

Nova Helix Operation Manual



NovaHelix
receiver



Company profile



In-house R&D development team

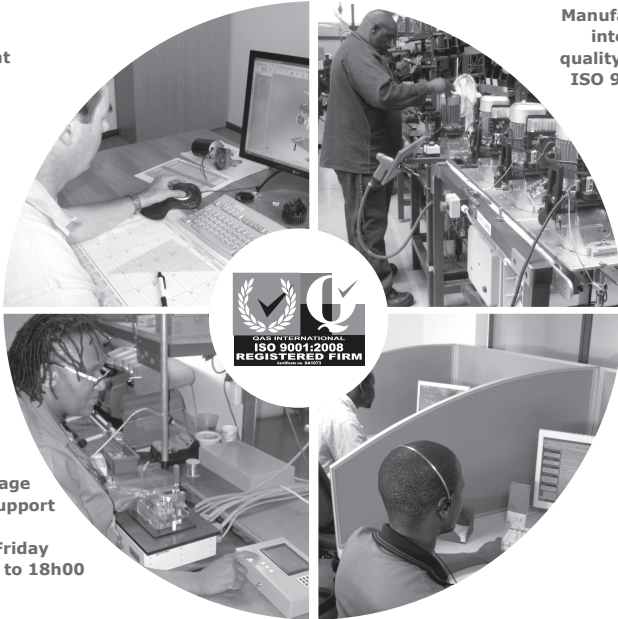

Manufactures to international quality standard ISO 9001:2008

After-sales multi-language Technical Support

**Monday to Friday from 07h00 to 18h00 GMT+2
Saturdays 08h00 to 16h30 GMT +2**

100% testing of products



Sales and technical support to Africa, Europe, Asia, the Americas, Australia and the Pacific

Centurion Systems (Pty) Ltd reserves the right to make changes to the products described in this manual without notice and without obligation to notify any persons of any such revisions or changes. Additionally, **Centurion Systems (Pty) Ltd** makes no representations or warranties with respect to this manual. No part of this document may be copied, stored in a retrieval system or transmitted in any form or by any means electronic, mechanical, optical or photographic, without the express prior written consent of **Centurion Systems (Pty) Ltd**.



Contents

1.	Nova Helix	page 4
2.	Glossary of Terms	page 5
3.	The Master Transmitter Interface	page 10
3.1.	Learning the First Master	page 10
3.2.	Learning additional Transmitters	page 11
3.3.	Demastering Buttons	page 12
3.4.	Deleting Buttons	page 13
4.	The Jumper Interface	page 14
4.1.	Link Learning	page 14
4.2.	Remastering Buttons	page 15
	4.2.1. Link Learn Remastering	page 15
	4.2.2. Master Learn Remastering	page 16
4.3.	Bulk Demastering	page 16
4.4.	Autolearn Mode	page 17
4.5.	Link Erase Mode	page 18
5.	Outputs	page 22
5.1.	Output configuration	page 22
5.2.	Simultaneous Primary Channel Activation	page 24
5.3.	Non-Volatile Latches (Sticky Latches)	page 24
5.4.	Beep-On-Activation	page 26
6.	Disabling Jumpers J1 and J2	page 26
7.	Configuring the Special Features	page 27
8.	SmartSwitch II Interface Capability	page 28
9.	Appendices	page 30
9.1.	Appendix A - LED and Buzzer Indication Diagrams	page 30
9.2.	Appendix B - Example Autolearn Configuration Procedure	page 31
9.3.	Appendix C - Example of Nova Helix Output Logic	page 32

1. Nova Helix

The operation manual describes the operation of the Nova Helix receivers.

- The Nova Helix functionality allows for both "Master" learning and "Link" learning
- Multichannel receivers support up to 15 unique output channels (SmartSwitch II devices act as the additional physical outputs)
- All receivers support the ability to disable the function jumpers, J1 and J2 for additional security
- All receivers support SmartSwitch II interfacing capability
- All receivers add panic functionality
- All receivers support independently configurable activation settings for all channels. These settings include enabling/disabling latching and panic functionality. In addition, it is possible to adjust the pulse time on pulsed channels with the following pulse time options - 350ms, 1s, 2s, 3s, 4s ..., 240s (4min)
- All receivers support the new timed Autolearn feature
- Multichannel receivers support advanced channel mapping functionality during Autolearn
- All receivers support sticky latch functionality
- Multichannel receivers support simultaneous channel activation functionality
- Multichannel receivers support beep-on-activation functionality

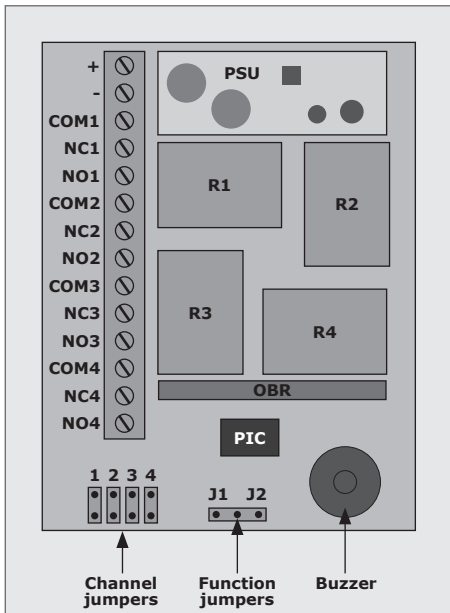

FIGURE 1: MULTICHANNEL RECEIVER

2. Glossary of Terms

Channel:

In the case of single-channel receivers, the receiver only has one channel - channel 1. In the case of multichannel receivers the receiver has, as the name suggests, multiple channels. The number of channels is not the same as the number of receiver outputs. The equation below describes the number of channels associated with a receiver, based on the number of unique channel jumpers outputs:

$$\text{No. of channels} = 2^{\text{No. of channel jumpers}} - 1$$

Thus, a receiver with four channel jumpers actually has 15 channels. Single-channel devices have no explicit channel jumpers; but one may assume that there is always one implied jumper. Channels never need to be numbered or addressed directly. Instead, channels are better tied to the functionality they are associated with. The term channel no longer refers to the physical output, but is a convenient way to describe the collective functionality that a transmitter activates.

As an example, consider the case in Figure 2. A multichannel receiver is used to control certain functions on a gate. The first receiver output is tied to the gate trigger. The second receiver output is used to activate the courtesy lights. Now, suppose the user would like one button to trigger the gates, one button to activate the courtesy lights, and one button to activate both simultaneously. To achieve this type of control, the user would learn a unique button to a unique channel that supports the required functionality.

- Button 1 is learnt to the channel that activates the first output only
- Button 2 is learnt to the channel that activates the second output only
- Button 3 is learnt to the channel that activates the first and second outputs simultaneously

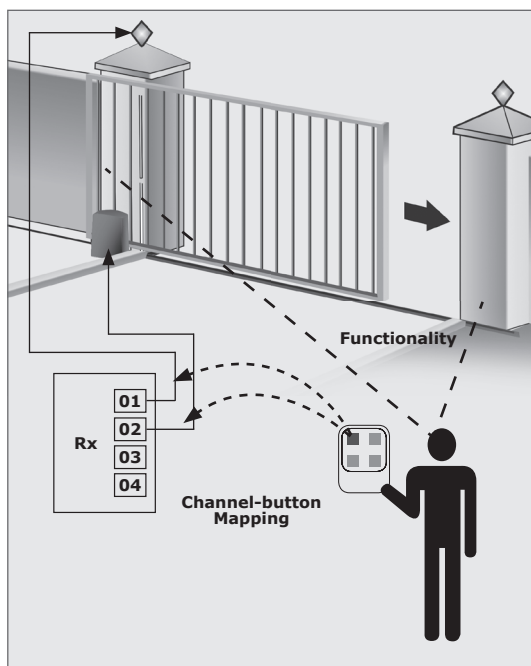

FIGURE 2. BUTTON TO FUNCTIONALITY MAPPING

As mentioned, channels need not be numbered explicitly; but for clarity the following channels are available on a receiver that supports four outputs:

	Out 1	Out 2	Out 3	Out 4
Channel 1	√			
Channel 2		√		
Channel 3	√	√		
Channel 4			√	
Channel 5	√		√	
Channel 6		√	√	
Channel 7	√	√	√	
Channel 8				√
Channel 9	√			√
Channel 10		√		√
Channel 11	√	√		√
Channel 12			√	√
Channel 13	√		√	√
Channel 14		√	√	√
Channel 15	√	√	√	√

TABLE 1. CHANNEL TO OUTPUT RELATIONSHIP

Simultaneous Channel Activation:

Simultaneous activation is a feature that is enabled on multichannel receivers that allows a transmitter button to activate multiple primary channels simultaneously.

The primary channels are equivalent to the outputs referred to in the section above (Out 1, 2, 3, and 4). Each of the primary channels that are activated simultaneously will inherit their individual activation settings. For example, suppose a user learns a button to activate primary channels 1, 2, and 4 (Outputs 1, 2 and 3 on the receiver). Individually the channels are configured with the following activation settings:

- Channel 1 has a one second pulse time
- Channel 2 has a four second pulse time
- Channel 4 is a latching channel

When the channels are activated simultaneously, the activation settings are applied as if the channels were activated individually. In other words, channel 1 activates for one second, channel 2 activates for four seconds, and channel 4 toggles its current output state.

It is possible, and desirable in some cases, to disable the simultaneous channel activation feature. To effect this, the multichannel receiver must be powered up with a special combination of jumpers fitted.

Channel Compartment:

Every channel that has unique functionality, has its own unique channel compartment. A channel compartment is a memory space that stores all the transmitter buttons that activate the functionality associated with the channel. Because channel compartments are unique, certain operations can be applied to a channel compartment in isolation. For example, a user may delete, or bulk demaster an entire channel compartment, thereby modifying all remotes associated with a particular type of functionality. Although the concept applies to the single-channel variants, it is practically obviated since there is only ever one channel to modify - operating on channel one is equivalent to operating on the entire transmitter memory space.

Channel Jumpers:

Multichannel receivers have four channel jumpers. The channel jumpers are used to select a particular channel. Each jumper relates to a particular physical receiver output. A channel is selected by placing links on the jumpers associated with the functionality of interest. As specified in the channel nomenclature section above, the actual channel number is not important. The user must simply place jumpers based on the functionality that is of interest. However, it is worthwhile noting that the channel selected by fitting links on jumpers 1 and 2, for example, is different to the one selected by placing a link on jumper 1 alone. Hence the usefulness of using the term channel to describe collective functionality.

Channel jumpers behave differently when discussing the SmartSwitch II interface. The jumpers are used to select a 4-bit binary address that addresses a particular SmartSwitch II device on the interface bus. Table 2 below documents the jumper settings to address a particular SmartSwitch II device. A SmartSwitch II device address is nothing more than a receiver channel output.

Table 2 illustrates that a transmitter button that is learnt to a particular channel will simultaneously activate the onboard relays and the SmartSwitch II device with the device address indicated (unless simultaneous primary channel activation is disabled).

Sticky Latches:

This is a special feature on all receiver variants that allows the receiver to restore its output state on power loss. When power is restored, the output will assume the state it last reflected prior to the receiver losing power. Normally a receiver that has latched channels will always power-up with the channels unlatched; regardless of the output state of the channel prior to power loss. The sticky latch feature addresses this problem (in applications where it is seen as a problem), and restores the output state of the latch to its state prior to power-loss.

Beep-on-Activation:

This is a special feature on multichannel receiver variants that emits a short beep from the buzzer on the receiver, when a button that is learnt into the receiver is pressed. It is useful in cases where the user is within audible range of the receiver and would like an acknowledgment that the transmitter transaction has been successfully received and decoded by the receiver.

The feature can be enabled and disabled on multichannel variants.















Channel	Jumper Setting	Activates SmartSwitch II Device	Activates Relays on Receiver
Channel 1	 C1 C2 C3 C4	1	1
Channel 2	 C1 C2 C3 C4	2	2
Channel 3	 C1 C2 C3 C4	3	1 & 2
Channel 4	 C1 C2 C3 C4	4	3
Channel 5	 C1 C2 C3 C4	5	1 & 3
Channel 6	 C1 C2 C3 C4	6	2 & 3
Channel 7	 C1 C2 C3 C4	7	1, 2 & 3
Channel 8	 C1 C2 C3 C4	8	4
Channel 9	 C1 C2 C3 C4	9	1 & 4
Channel 10	 C1 C2 C3 C4	10	2 & 4
Channel 11	 C1 C2 C3 C4	11	1, 2 & 4
Channel 12	 C1 C2 C3 C4	12	3 & 4
Channel 13	 C1 C2 C3 C4	13	1, 3 & 4
Channel 14	 C1 C2 C3 C4	14	2, 3 & 4
Channel 15	 C1 C2 C3 C4	15	1, 2, 3 & 4

TABLE 2. CHANNEL JUMPER TO SMARTSWITCH II DEVICE MAPPING

Primary Channels:

Primary channel is a term that is used to refer to the channels that drive a single output (typically a relay) on the receiver board. The table below lists the primary channels for the various receiver variants. The cells highlighted in orange indicate that the channels are accessible through the learning interface (four channel jumpers, hence 15 channels), but none of the channels are primary channels. The single-channel variants have one primary channel, channel 1, and cannot access any of the other channels.

Channel	4 Ch.	2 Ch.	1 Ch.	Voyager
Channel 1	√	√	√	√
Channel 2	√	√	N/A	N/A
Channel 3				
Channel 4	√			
Channel 5				
Channel 6				
Channel 7				
Channel 8	√			
Channel 9				
Channel 10				
Channel 11				
Channel 12				
Channel 13				
Channel 14				
Channel 15				

TABLE 3. PRIMARY CHANNELS FOR THE VARIOUS RECEIVER VARIANTS

3. The Master Transmitter Interface

3.1. Learning the First Master

1. To learn the first transmitter button into the receiver, the receiver 'Tx Memory' must be blank. As an extension of this requirement, the channel compartment related to the function being learnt must be blank. Although generally applicable, this extension only really has meaning when discussing multichannel receivers.
2. In the case of multichannel receivers, start by placing links on the required channel jumpers to select the functionality of interest. This informs the receiver that a channel other than channel 1 will be mastered.
3. Press and hold a new transmitter button. This button is said to master the channel that has been selected for learning.
4. While the button is held down, the receiver's Status LED will flash quickly to indicate that the system is receiving a new Nova button that is not stored in any channel compartment in memory.
5. After approximately 5 seconds the receiver will learn the transmitter button into memory. The receiver will acknowledge the learning operation; in particular, the LED on the receiver will begin to flash slowly, the buzzer will emit a short double beep, and the channel functionality will activate.
6. The button can be released once the learning operation is acknowledged.
7. If the button is not released following the learning operation acknowledgement, the receiver will begin to enter learn mode for the particular channel of interest.
8. To effect this mode, continue to hold the button down, and count the slow flashes of the Status LED on the receiver. After 10 flashes, or equivalently, 10 seconds, the receiver will enter learn mode. The transition into this mode is indicated by a long beep from the receiver. In other words, it is possible to learn the first master and enter learn mode with one press (even if it is for an extended period of time – 15s+) of the transmitter. For further information on learn mode, refer to the next section dealing with learning additional remotes.

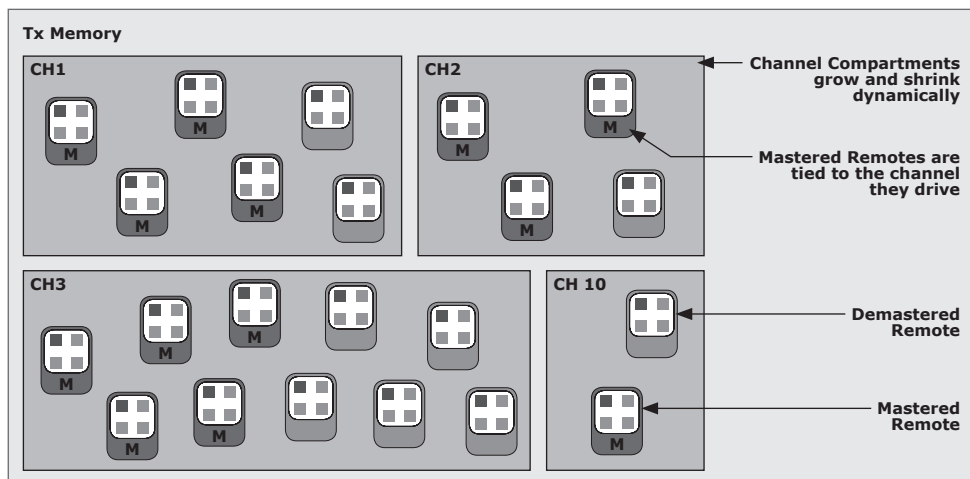

FIGURE 2. NOVA HELIX MEMORY STRUCTURE

3.2. Learning Additional Transmitters

1. To learn additional transmitters into memory using a master transmitter implies that at least one transmitter button (that must be a master) is already learnt into memory. In other words, the channel compartment of interest must not be blank, and the user must have access to a master button associated with that channel compartment.
2. Press and hold a master button that has functionality on the receiver that needs to be copied. The receiver LED will flash once per second as per the standard master flash. The master button must be held for between 10 and 20 seconds. After 10 seconds, the receiver will provide a long beep to indicate that it has entered the learn mode window. Releasing the master button within this 10-20 second learn mode window, will place the receiver in learn mode. The receiver will stay in learn mode, for a particular channel, for a period of ten seconds, failing any additional button presses. While in learn mode the LED on the receiver will remain on.
3. Any unlearnt button that is pressed, and held down for a minimum of three seconds, while in learn mode, will be added to the receiver.
4. The Status LED will switch off while the unlearnt button is activated within the three second learning window. This confirms three things:
 - a. The button transaction is being received by the receiver
 - b. The button is not learnt into memory. If the button is already learnt into memory, the LED will not turn off (for the complete learning period) when the button is pressed (refer to points 6.a and 6.b. below for further clarification)
 - c. The button learning process is not finalised.
5. Once the three second period has elapsed, the LED will turn on again and the buzzer will provide a double-beep. This serves as visual and audible confirmation that the receiver has learnt the button being pressed. (Refer to Appendix A on page 30 for a description of the LED and buzzer feedback)
6. If the button is already learned into memory when it is pressed, the leading edge of the transmitter transaction is acknowledged with a short beep.
 - a. The LED will not switch off for a button that is already learned into memory as a master.
 - b. The LED will flash periodically (64ms on/448ms off) if the button is demastered, and is being held down to remaster it. Following the three second learning window, the button will be remastered. The LED will switch on again, and the buzzer will beep once briefly to confirm the successful remastering operation.
7. Any additional remotes learned into memory are also given master privileges. Hence, every button added to the receiver in this way automatically becomes a master for functionality associated with the master that placed the receiver in learn mode.
8. Any button that is pressed while the receiver is in learn mode (whether the button is already learnt into memory or not) will extend learn mode by an additional 10 seconds from the time the button is released.
9. If no additional buttons are pressed within the 10s learning period, the receiver will automatically exit learn mode. This exit is signalled by an extended single beep. The Status LED also switches off and resumes its responsibilities in normal mode.

3.3. Demastering Buttons

When a Nova Helix system is commissioned, all buttons learnt into the receiver are granted master privileges for that receiver. From a security perspective, this is not always desirable. To overcome this potential security issue, the system has the ability to 'demaster' master buttons.

1. Press and hold a master button that is associated with the same functionality as the buttons that need to be demastered. The master button must be pressed for between 20 and 30 seconds.
2. After the first 10 seconds, the receiver will beep once to indicate that it has entered the learn mode time window. The user must continue to hold down the master button.
3. Upon exit from the learn mode window, and entry to the demaster mode window, at 20 seconds, the receiver issues a long double beep.
4. Following the long double beep, the master button must be released. At this point the receiver transitions to demaster mode.
5. The LED will flash periodically with two quick flashes (64ms on/256ms off) and then a longer pause (352ms). (Refer to Appendix A on page 30 for a description of the LED and buzzer feedback) The receiver will only enter demastering mode for a particular channel. The receiver will remain in demastering mode for a period of 10 seconds failing any additional button presses.
6. While the receiver is in demastering mode, any mastered button that is pressed for three or more seconds (but less than 10 seconds) and is associated with the functionality that the receiver is currently demastering, is itself demastered. As with learn mode, buttons are acted upon on their trailing edge - referred to as 'trailing edge demastering' - this means the button is only demastered when it is released.
7. The leading edge of the transmitter transaction is acknowledged with a short beep. This beep occurs irrespective of whether the button is a master button or not.
8. The receiver will demaster a button if, and only if, the button is a master button and is associated with the channel of the master that placed the receiver in demastering mode. A demastering operation is acknowledged with a short triple beep. The triple beep acknowledgement is the point at which the transmitter button is primed for demastering. Actual demastering only takes place when the button is released. If the button is not released, and is held pressed for a total of 10 or more seconds, then the button enters the deletion window (refer to the section, Deleting Buttons, for further information on this operation).
9. If no additional buttons are pressed within the 10s demastering period, the receiver will automatically exit demaster mode. This exit is signalled by an extended single beep. The Status LED also stops flashing and resumes its responsibilities in normal mode.

3.4. Deleting Buttons

A mechanism exists to delete an individual button that is already learnt into memory. The transmitter must be available to delete the button in question from the receiver. In other words, the transmitter may not be lost or stolen to remove a button from the receiver.

1. Follow the steps to enter demastering mode. For reference follow steps one through four in the Demastering Buttons section. The demastering mode channel need not be the same as the channel associated with the button that must be deleted.
2. While in demastering mode, press and hold the button that must be deleted for between 10 and 20 seconds.
3. On the leading edge of the button press, the receiver will emit a short single beep. This is an indication that the receiver is receiving the button transmission.
4. After holding down the button for three seconds, the receiver will do one of two things:
 - a. Emit a short triple beep if the button being deleted is a master button. This triple beep indicates that the receiver is primed to demaster the button. If the button is released in this window, it will simply be demastered (refer to the previous section, Demastering Buttons, for further information on this operation).
 - b. Do nothing because the button being deleted is not a mastered button, and is simply a button learnt into memory.
5. After holding down the button for 10 seconds, the receiver will emit a short beep to indicate that the receiver is primed to delete the button.
6. After the short beep, the button must be released. As with all the other modes, the required action (deletion in this case) only takes place on the trailing edge of the transmitter transaction.
7. The receiver indicates a successful deletion operation with four short beeps. Furthermore, the LED flashes quickly (64ms on/64ms off) for a period of 700ms.
8. Once deleted, the system transitions back to demastering mode. Further buttons may be deleted by following steps 2 through 7. Remember, the system must remain in demastering mode to delete buttons.
9. If no additional buttons are pressed within the 10s demastering period, the receiver will automatically exit demaster mode. This exit is signalled by an extended single beep. The Status LED also stops flashing and resumes its responsibilities in normal mode.

4. The Jumper Interface

Table 4 details how to enter a particular jumper-based mode of operation by linking a function jumper (J1 or J2) with power on the board, or before powering up the board. The table below represents the functionality for multichannel receivers. Generally, a channel must be set via the channel jumpers to carry out a particular operation with respect to said channel. There are a few exceptions to this, where not placing links on the channel jumpers invokes special operations.

- If any channel jumpers are linked, then the settings and modes of operation will pertain to that channel
- If no jumpers are linked, then the system defaults to channel 1

In the case of single-channel receivers, the table below reduces in complexity by removing all the “No Channel Specified” cases. Even though there is no explicit channel jumper, one may assume that the channel 1 jumper exists, and is always bridged.

		While Power is On				On Power Up		
		Channel Specified		No Channel Specified		Memory Blank	Memory Non-Blank	
J1		Learns a button to the specified channel		Learns a button to the default channel, channel 1		Autolearn Mode	Channel Specified	No Channel Specified
							Bulk Demaster Channel	Bulk Demaster All
J2		Memory Blank		Memory Non-Blank		Channel Specified	No Channel Specified	
		Channel Specified	No Channel Specified	Channel Specified	No Channel Specified			
		N/A	Settings Erase	Erase all buttons in channel	Erase all buttons	Channel Configuration	N/A	

TABLE 4. JUMPER INTERFACE

4.1. Link Learning

1. Fit the link to J1 with power on the receiver. This puts the receiver in link learn mode. On multichannel receivers, fit the links on the channel jumpers to specify the functionality that is required for remotes that are to be learned into the system. If no channel jumpers are linked, the system defaults to learning to channel 1.
2. When jumper J1 is fitted, the LED will turn on as per master learn mode.
3. Press a new button to learn it into the system. As with master learn mode, the system learns a new button on the trailing edge (i.e. *trailing edge learning*) of the transmitter transaction.
4. The leading edge of the transmitter transaction is acknowledged with a short beep. This beep occurs irrespective of whether the button is already learned into memory or not.

5. If the button is a new button, the LED will switch off while the button remains pressed to confirm that the system has detected that a new transmitter button has been pressed. The trailing edge of the transmitter transaction is acknowledged with a short double beep, confirming that the button has been successfully added to the receiver's memory. (Refer to Appendix A on page 30 for a description of the LED and buzzer feedback)
6. If the button is a demastered button, the LED will flash while the button is held down. The trailing edge of the transmitter transaction is acknowledged with a short single beep, confirming that the button has been successfully remastered.
 - a. If any channel jumpers are bridged, then buttons that are demastered can only be remastered if their associated channel matches the channel selected by the channel jumpers.
 - b. If no channel jumpers are bridged, then the system will remaster any demastered buttons; regardless of the button's associated channel.
7. Any additional remotes learned into memory are also given master privileges. Hence, every button added to the receiver in this way automatically becomes a master for functionality associated with the channel specified by the channel jumpers.
8. Obviously, there is no timeout associated with link learning mode since the link bridging jumper, J1, forces the receiver to stay in link learn mode.

4.2. Remastering Buttons

If a button has been demastered, it can be remastered. There are two methods to achieve this:

4.2.1. Link Learn Remastering

1. To remaster a remote, start by entering link learn mode. For reference, follow steps 1 and 2 in the Link Learning section
2. To remaster buttons associated with a specific channel, fit the channel jumper links for that channel. With links fitted, only buttons associated with selected channels can be remastered. All other buttons will register on the receiver, but will not be processed (as per point 6.a in the Link Learning section).
3. To remaster buttons without regard for the channel they are associated with, do not fit any links on the channel jumpers. This will inform the receiver that it must remaster any demastered buttons that are pressed while in this mode (as per point 6.b in the Link Learning section).
4. With the learn link fitted, press and release a demastered button to remaster it. If a new button (button not learned into the system) is pressed in link learn mode, it will be learned into the system (refer to the previous section, Link Learning for more information).
5. The leading edge of the demastered button transaction is acknowledged with a short beep. This beep occurs irrespective of whether the button is mastered or demastered (in fact, it will occur irrespective of whether the button is in memory or not).
6. While the demastered button is held down, the LED will flash (64ms on/448ms off) to register that the button transmission is being received, and that the button is a demastered button. (Refer to Appendix A on page 30 for a description of the LED and buzzer feedback).

7. When the demastered button is released, the receiver will complete the remastering operation and remaster the button. A single short beep will signal the end of the operation, confirming to the user that the button has been remastered. The LED will turn on again at the end of the operation.
8. When jumper J1 is removed, the receiver will exit link learn mode.

4.2.2. Master Learn Remastering

1. To remaster a remote in this mode, start by entering master learn mode. Refer to steps 1 and 2 in the Learning Additional Transmitters section on page 11.
2. Only buttons that are associated with the channel of the master button that entered master learn mode can be remastered in this mode.
3. Press and hold a demastered button (associated with the relevant channel - see point 2 above), for a minimum of three seconds to remaster it. If a new button (button not learned into the system) is pressed in master learn mode for more than three seconds, it will be learned into the system (refer to the section, Learning Additional Transmitters on page 11 for more information).
4. The leading edge of the demastered button transaction is acknowledged with a short beep. This beep occurs irrespective of whether the button is mastered or demastered.
5. While the demastered button is held down within the demastering window (minimum 3s), the LED will flash (64ms on/448ms off) to register that the button transmission is being received, and that the button is a demastered button. (Refer to Appendix A on page 30 for a description of the LED and buzzer feedback)
6. Once the demastering period has elapsed (minimum three seconds), the LED will turn on and the buzzer will provide a single short beep. This serves as visual and audible confirmation that the receiver has learnt the button being pressed. The LED will turn on again at the end of the operation.
7. Once remastered, the system transitions back to master learn mode. Further buttons may be remastered by following steps 3 through 6.
8. If no additional buttons are pressed within the 10s master learn mode period, the receiver will automatically exit learn mode. This exit is signalled by an extended single beep. The Status LED will turn off and resume its responsibilities in normal mode.

4.3. Bulk Demastering

Since all remotes that are added to a receiver are always added with master privileges, a mechanism has been exposed on the Nova Helix receivers that allows certain groups of remotes, currently learnt on the receiver, to be demastered simultaneously.

To bulk demaster remotes, follow the procedure highlighted below:

1. Ensure that there is no power on the receiver.
2. If the receiver is a multichannel receiver, place links on the channel jumpers to select the channel that will be bulk demastered. All the buttons associated with this channel will be demastered. If all buttons (i.e. buttons associated with any channel) must be demastered, leave the channel jumpers unlinked. Single-channel receivers always bulk demaster all buttons because there is only one channel compartment.

3. Fit the link across J1 and power up the receiver. If the channel compartment pertaining to the selected channel is not blank (has at least one button, whether it is mastered or not, associated with the channel), then the receiver will enter bulk demaster mode. If the entire memory is selected for demastering, then at least one button must be learnt into memory (on any channel) to enter bulk demaster mode.
4. After the firmware version number has flashed on the Status LED, the LED will begin to flash quickly to signal that the receiver has entered bulk demaster mode. If the LED does not flash quickly, then the system is not in bulk demaster mode, either because jumper J1 was not linked correctly before power-up, or because there are no buttons learnt into memory (or associated with the channel selected by the channel jumpers).
5. To confirm the bulk demastering operation, jumper J1 must be removed. If the receiver is powered down before the jumper is removed, the bulk demastering operation is not executed. This is useful if the mode is entered accidentally and no buttons must actually be demastered.

In step 3 above, it is noted that the system will only enter bulk demaster mode if at least one button is learnt into the system, and associated with the channel specified by the channel jumpers. If there is no button in the relevant channel compartment, then the receiver transitions into Autolearn mode for the selected channel. Refer to the Autolearn section for more information.

4.4. Autolearn Mode

Multichannel receivers support the ability to map buttons to channels during the Autolearn process. Part of the Autolearn setup procedure requires the establishment of an association table. This table will be used for all buttons learned into memory during the actual Autolearn procedure. Autolearn mode is also limited to a maximum of 7 days before it times out. This prevents a user from accidentally leaving the system in Autolearn on an indefinite basis. There are security risks linked with a system that is placed in Autolearn mode. The 7-day timeout will minimise these risks while still providing the convenience of auto-learning buttons.

1. Channel compartments configured for Autolearn must be blank. In other words, the entire Tx Memory needn't be blank to enter Autolearn, only the relevant compartments. As a result, it is possible to enter Autolearn mode multiple times; so long as the channels configured for the Autolearn session are blank.
2. Fit the desired channel links for the channel that is intended for auto-learning. It is possible to omit channel links and enter Autolearn for channel 1, but only if the channel is blank. In the case of single-channel receivers, this step can be omitted since there are no channel jumpers. Single-channel receivers always enter Autolearn mode for channel 1.
3. Fit the link across J1 and power up the receiver. One of two possible situations will result:
 - a. The selected channel (set via the channel jumpers) is blank. In this case, the system enters the Autolearn Commissioning procedure. The receiver remains in this state while the link on J1 remains fitted. While in the commissioning state, the LED on the receiver remains on. Entry to the commissioning state is also signalled by a long beep from the buzzer. Continue to step four.
 - b. The selected channel (set via the channel jumpers) is not blank, or no channel has been selected (no channel links fitted). In this case the system enters bulk demaster mode. Refer to the section with the title, Bulk Demastering, for more information on the behaviour of the system in this mode.

4. Press a button on a transmitter to establish the button-to-functionality (channel) relationship. The transmitter that is used to establish the relationship is not learned into memory at this initial stage (although a button that is already learnt into memory may be used). It is purely used to establish the relationship between a button and the selected channel. The LED will turn off while a button is pressed. The LED will turn on again and the buzzer will sound briefly when the button is released. This confirms that the button has been successfully received and added to the association table.
5. The last button that is pressed for a given channel will dictate the button-to-functionality relationship. For example, suppose button 1 is initially pressed and associated with a channel, channel 3 for argument's sake. If button 2 is pressed subsequently, and it is the last button to be pressed during the channel 3 association process, then button 2 will ultimately be the button associated with channel 3.
6. To add another channel to the current Autolearn operation, change the channel links to the new channel of interest. Remember, only channels that are blank can be placed in Autolearn mode. If a channel that is not blank is selected via the channel jumpers, the LED will turn off on button press, but the receiver will not generate a beep when the button is released. This will signal that the channel is not blank and therefore that Autolearn may not be enabled for that channel.
7. Repeat steps 4 through 6 to establish button-to-functionality relationships for all the (blank) channels of interest. (Refer to Appendix B on page 31 for an example of the Autolearn configuration procedure.)
8. Once the association table has been finalised, remove jumper J1. This confirms the mapping and enters Autolearn mode. The buzzer will beep four times to confirm the transition to Autolearn mode. While in Autolearn mode, the LED will remain on while the system is idle. When the correct transmitter button (only buttons registered in the association table are accepted) is pressed, the LED will turn off. When the button is released, the LED will turn on again. The buzzer will beep twice briefly to indicate that the button has been successfully learnt. All buttons are learned as master buttons. The receiver outputs associated with the mapped channel will also activate - they will only activate on the trailing edge of the learning transaction.
9. Once learnt, the LED will stay on while a valid transmitter button is pressed and the buzzer will not beep on the leading or trailing edge of the transaction. The relevant receiver outputs will activate on the leading edge of the transmitter transaction.
10. Autolearn mode will exit automatically after seven days (so long as power is not lost to the receiver). To exit Autolearn mode early, a master button must be pressed and held for between 10 and 20 seconds. Any valid master button will exit Autolearn - it need not be a button that is currently part of the Autolearn process.

4.5. Link Erase Mode

There are two primary types of erase that pertain to all the receiver variants:

- Transmitter Memory Erase
- Settings Memory Erase

The procedure to perform the erase operation is documented below:

1. Start with the receiver powered up
2. If a particular channel compartment must be erased (in other words, if all the remote buttons associated with a particular channel must be erased), then fit the channel jumpers that select the desired channel.

3. If the entire memory must be erased (or the Settings Memory must be erased), then do not fit links to any of the channel jumpers.
4. Fit a link to jumper J2.
5. The LED will flash 10 times to indicate that it is about to enter the erase procedure. The link may be removed at this early stage without the erase operation completing.
6. After the LED has flashed 10 times, it will turn on. This indicates that the receiver is now primed for the erase operation to take place. The procedure may still be aborted at this late stage by removing power to the receiver.
7. Remove the link across jumper J2 to complete the erase operation.
8. The LED will switch off once the relevant memory section is erased. The receiver will return to normal operation after the erase operation completes.

The property that differentiates the two erase operations is the state of the Transmitter Memory. If the memory is not blank (i.e. buttons are learnt into memory), then the receiver will perform the Transmitter Memory Erase operation. If, on the other hand, the Transmitter Memory is blank, then the Settings Memory Erase operation is performed.

Table 5 documents the settings that are erased in each of the erase cases.

Channel Erase	Transmitter Memory Erase	Settings Memory Erase
<ul style="list-style-type: none"> • Clears channel compartment • Clears non-volatile latch state for channel • Clears all SmartSwitch II device outputs that may be active (both pulsed and latched outputs) • Clears all primary channel relay outputs 	<ul style="list-style-type: none"> • Erases entire Transmitter Memory space (all channel compartments) • Clears non-volatile latch state for all channels • Clears all SmartSwitch II device outputs that may be active (both pulsed and latched outputs) • Clears all primary channel relay outputs 	<ul style="list-style-type: none"> • Erases entire Transmitter Memory space (all channel compartments) • Resets latch settings for all channels • Resets panic settings for all channels • Restores default relay pulse time for all channels • Clears all SmartSwitch II device outputs that may be active (both pulsed and latched outputs) • Sets all SmartSwitch II device counters to zero (SmartSwitch II devices will have to be paired again) • Clears non-volatile latch state for all channels • Clears all primary channel relay outputs • Sets the receiver's special feature settings back to their defaults

TABLE 5. ERASE ACTIONS PERFORMED DURING ERASE OPERATIONS ON MULTICHANNEL RECEIVERS

Table 6 details the respective default settings when a Settings Memory Erase operation is performed.

	Latch Setting	Panic Setting	Pulse Time	Latch State	SS II Counter
Channel 1	Disabled	Disabled	350ms	Off	Zeroed
Channel 2	Disabled	Disabled	350ms	Off	Zeroed
Channel 3	Disabled	Disabled	350ms	Off	Zeroed
Channel 4	Disabled	Disabled	350ms	Off	Zeroed
Channel 5	Disabled	Disabled	350ms	Off	Zeroed
Channel 6	Disabled	Disabled	350ms	Off	Zeroed
Channel 7	Disabled	Disabled	350ms	Off	Zeroed
Channel 8	Disabled	Disabled	350ms	Off	Zeroed
Channel 9	Disabled	Disabled	350ms	Off	Zeroed
Channel 10	Disabled	Disabled	350ms	Off	Zeroed
Channel 11	Disabled	Disabled	350ms	Off	Zeroed
Channel 12	Disabled	Disabled	350ms	Off	Zeroed
Channel 13	Disabled	Disabled	3s	Off	Zeroed
Channel 14	Enabled	Disabled	350ms	Off	Zeroed
Channel 15	Disabled	Enabled	350ms	Off	Zeroed

TABLE 6. OUTPUT SETTINGS

It should be clear from Table 5 that channels 13, 14, and 15 are special channels. These channels were given special default settings so that a user can easily learn to channels that enable particular functionality. Table 7 outlines the potential special purposes.

Channel 13	Striker/Maglock activation
Channel 14	Holiday lockout (or equivalent bi-stable function)
Channel 15	Duress or alarm panic activation

TABLE 7. CHANNELS WITH SPECIAL DEFAULT FUNCTIONALITY

Table 8 details the respective default settings for the receiver's special features.

	Simultaneous Activation	Sticky Latch	Beep-On-Activation
Special Feature Setting	Enabled	Enabled	Disabled

TABLE 8. DEFAULT SPECIAL FEATURE SETTINGS

Single-channel receiver variants perform a limited subset of the operations performed during the erase procedures. The table below is equivalent to Table 5, but outlines the erase operations for the single-channel variants.

Channel Erase	Settings Memory Erase
<ul style="list-style-type: none"> • Clears channel compartment (equivalent to erasing the entire memory) • Clears non-volatile latch state for channel • Clears the SmartSwitch II device output that may be active (in the pulsed or latched case) • Clears the channel 1 output on the receiver 	<ul style="list-style-type: none"> • Erases entire Transmitter Memory space • Resets latch settings on channel 1 • Resets panic settings on channel 1 • Restores default relay pulse time • Clears the SmartSwitch II device output that may be active (in the pulsed or latched case) • Sets the SmartSwitch II device counter to zero (SmartSwitch II device will have to be paired again) • Clears non-volatile latch state • Clears the channel 1 output on the receiver

TABLE 9. ERASE ACTIONS PERFORMED DURING ERASE OPERATIONS ON SINGLE-CHANNEL RECEIVERS

5. Outputs

5.1. Output Configuration

Channel settings modify the way a receiver output responds when it is activated. The output can be configured to act as a latching output, a panic output or any combination thereof. A latching output provides the required drive logic for alarm or equivalent output functionality. Every button transaction associated with a latching output will toggle the current output state of the channel.

If the channel is configured as a latching output, then by default, the state of the physical output at the time of power loss is restored when power is restored. This is a new feature associated with the Nova Helix receivers and is referred to as the Sticky Latch feature. It can be disabled if required on multi-channel receiver variants. Sticky latches provide a fault-tolerant and secure remote control system. SmartSwitch II devices provide the same non-volatile latching state facility. This means that if power is lost to the SmartSwitch II device, but is not lost to the receiver, then the SmartSwitch II device will restore its latched output state when its power is restored.

In the case of multichannel receivers, channel settings are set on an output by output basis. To select a particular output, link the relevant output jumpers (channel jumpers). For example: To set output 1, place a link on channel jumper C1 only. To set channel 11 (a SmartSwitch II device output), place links on channel jumpers C1, C2 and C4 (the binary combination of C1, C2, and C4 that results in 11 - b'1011').

Proceed as per the steps below to set the required output configuration for the specified output.

1. Power down the receiver, and link the relevant channel jumpers to configure the respective receiver outputs. On single-channel receiver variants, the settings are always specified for output 1. On multichannel variants, if no channel is specified via the channel jumpers, the system will not enter channel configuration mode.
2. Link jumper J2, and power up the receiver.
3. After the firmware version number has flashed on the Status LED, the buzzer will provide three short beeps to acknowledge the fact that the receiver is powering up in channel configuration mode.
4. Press and hold any master button that is learnt into the system for approximately 3 seconds. The receiver will transition into channel configuration mode. The receiver will proceed to flash in the manner indicated in Table 10 - One short flash and then a 1 second delay. Then two short flashes and a 1 second delay. Then three short flashes and a 1 second delay. Finally four short flashes and a 1 second delay. While jumper J2 remains bridged the flashing process repeats itself indefinitely.
5. The link on J2 must be removed once the number of flashes on the receiver matches the number of flashes that will set the required output configuration - refer to Table 10.

LED FLASHES	LATCHING	PANIC
*	OFF	OFF
**	ON	OFF
***	OFF	ON
****	ON	ON

TABLE 10. CHANNEL CONFIGURATION

- Once the output configuration has been set, it is possible to proceed to set the output pulse time. This step may be skipped by either waiting 5 seconds for the receiver to time out, or by removing power from the board. In either of the two cases, the currently set output pulse time will be maintained.
- To adjust the relay output pulse time, fit the link across jumper J2 again. Ensure that this is done before the 5 second timeout period elapses.
- Once the link is fitted, the LED will illuminate for 3 seconds. If the link is removed within this three second window, the relay time is set to the minimum pulse time of 0.3s. In such a case, skip the next step and proceed to step 10.
- After the three second window, the LED will switch off and start flashing once per second. Counting LED flashes, or using a watch to keep track of the number of seconds that pass will determine the period of the output pulse time. When the desired time period is reached, the link on J2 must be removed.

Number of LED Flashes When J2 Link is Removed	Relay Output Pulse Time
Initial 3 Second Window	0.3s
1 flash	1.0s
2 flashes	2.0s
3 flashes	3.0s
...	...
240 flashes	4 minutes

TABLE 11. OUTPUT PULSE TIME SETTINGS

- If the link across jumper J2 is not removed after a period of 240 seconds, the LED will stay on permanently. If the jumper is removed after this, the receiver will set the maximum pulse time-period of 240s.
- The buzzer will beep briefly when the link is removed to confirm that the new time has been saved.
- The receiver will now exit channel configuration mode, transitioning to normal mode of operation. If additional receiver outputs must be configured, the above steps must be repeated for the relevant output.

5.2. Simultaneous Primary Channel Activation

The Nova Helix multichannel receivers provide the facility to activate their primary channels simultaneously. This facility combined with the ability to configure each of the outputs' settings independently allows for intelligent output activation. For example, on a two-channel receiver, channels 1 and 2 can be activated simultaneously by a single button. Channel 1 can be configured to provide a brief 300ms pulse, while channel 2 can be configured to provide a 3s output pulse. This might be useful to activate a gate operator using channel 1, and a striker lock (that is locking the gate) using channel 3.

To effect this multichannel activation, learn buttons to channels that have multiple channel jumpers bridged in their binary code. Table 1 in the section, Glossary of Terms, reflects this primary channel mapping. The table is included again for convenience.

	Primary Ch. 1	Primary Ch. 2	Primary Ch. 4	Primary Ch. 8
Channel 1	√			
Channel 2		√		
Channel 3	√	√		
Channel 4			√	
Channel 5	√		√	
Channel 6		√	√	
Channel 7	√	√	√	
Channel 8				√
Channel 9	√			√
Channel 10		√		√
Channel 11	√	√		√
Channel 12			√	√
Channel 13	√		√	√
Channel 14		√	√	√
Channel 15	√	√	√	√

TABLE 12

5.3. Non-Volatile Latches (Sticky Latches)

This is a special feature on all receiver variants that allows the receiver to restore its output state on power loss. When power is restored, the output will assume the state it last reflected prior to the receiver losing power. In the case of multichannel receivers the feature is applicable to any of the 15 channels, so long as the channels are configured as latched channels. In the case of the single-channel variants, the feature is only applicable to channel 1; as before, only when configured as a latched channel.

The feature is enabled by default on all receiver variants. It is only possible to configure the feature on multichannel receivers; single-channel variants always have the feature enabled. The feature is applied at receiver scope level - meaning that all latched channels on a receiver either globally have the feature enabled or disabled. To configure the feature on multichannel receivers, refer to the section, Configuring the Special Features, on page 27.

The feature applies to any SmartSwitch II device paired with a latched channel on a receiver. SmartSwitch II devices have this feature natively integrated. This means that if power is lost to the SmartSwitch II device, but not lost to the receiver, the SmartSwitch II device will still restore the output state of its latching output when power is restored. This applies even if the feature is disabled on the multichannel receiver that controls it. Refer to Table 13 for the latch state recovery rules for a SmartSwitch II device as it recovers from various power loss scenarios.

		SmartSwitch II Device		
		Power Remains	Power Lost	
Multi-Channel Receiver Device	Sticky Latch Feature Enabled	Power Remains	N/A	SmartSwitch II device restores its output state when its power is restored
		Power Lost	SmartSwitch II device is sent a command from the receiver to set its output to the output state of the receiver's channel prior to power loss	SmartSwitch II device restores its output state when its power is restored Subsequently (assuming power is restored to both devices simultaneously), the SmartSwitch II device is sent a command from the receiver to set its output to the output state of the receiver's channel prior to power loss
	Sticky Latch Feature Disabled	Power Remains	N/A	SmartSwitch II device restores its output state when its power is restored.
		Power Lost	SmartSwitch II device is sent a command from the receiver to clear its output state	SmartSwitch II device restores its output state when its power is restored Subsequently (assuming power is restored to both devices simultaneously), the SmartSwitch II device is sent a command to clear its output state

TABLE 13. LATCH STATE RECOVERY UNDER VARIOUS POWER LOSS SCENARIOS

5.4. Beep-On-Activation

Beep-on-activation is a special feature associated with multichannel receiver variants. It is a configurable feature that, if enabled, activates the buzzer on any press of a transmitter button that is learnt into memory. The feature is disabled on all multichannel receiver variants by default. To enable the feature refer to the section, Configuring the Special Features, on page 27.

The buzzer provides one short, 150ms beep when a valid button that is learnt into memory is pressed.

Panic channels override the beep-on-activation feature. This means that if a button is pressed, that is associated with a channel, or combination of channels, where at least one of the channels is a panic channel, the buzzer will not beep.

6. Disabling Jumpers J1 and J2

It is possible to disable the functionality associated with jumpers J1 and J2. Receivers are often placed in elevated environments to optimise the range of the receiver. Often, little or no attention is paid to securing the receiver. If the receiver unit is not secured it is possible for a perpetrator to access the jumpers on the receiver and learn a remote into the system without the knowledge or consent of the user. The Nova Helix range includes functionality to disable the jumpers. With a master remote, the jumpers may be re-enabled at any stage.

The following procedure documents disabling the jumper interface on the Nova Helix range of receivers.

1. At least one master transmitter must be learned into the receiver memory.
2. Press and hold a master button for between 20 and 30 seconds. This will cause the receiver to enter demastering mode.
3. While in this mode, fit jumper J2. The status LED will illuminate while the jumper remains bridged.
4. When jumper J2 is removed, both jumpers will be disabled and no further jumper operations may be performed.

To re-enable the jumper interface, repeat steps 1 through 4 again.

As a special note, the following system locks are possible:

- Disabling the jumper interface
- Demastering all remotes in memory (thereby rendering any further master based learning impossible)

It is, however, not possible to have both system locks in place indefinitely.

On every power cycle of the Nova Helix receiver, the memory is interrogated to establish whether any masters exist in memory. If no masters exist, and the jumper interface has been disabled, then the jumper interface is forcefully re-enabled. Once the jumper interface is re-enabled it is possible to administrate the system again.

7. Configuring the Special Features

The multichannel receiver variants have the facility to enable and/or disable the following special features:

- Simultaneous primary channel activation
- Non-volatile latches (sticky latches)
- Beep-on-activation

To configure the special features, a combination of jumper settings are required on power-up. Single-channel receiver variants do not support the special features because they do not have any physical channel jumpers to bridge.

The most important of the jumper settings is the link placed across the active pins of channel jumpers 1 and 2 - refer to Figure 3. This is the jumper configuration that informs the micro controller that certain special features are being configured.

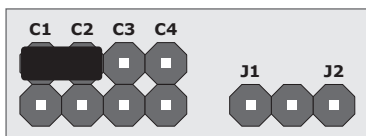

FIGURE 3

The remaining jumper settings merely inform the micro controller which of the special features is being configured, and how that feature is to be configured. Channel jumpers 3 and 4 determine which of the special features is being configured.

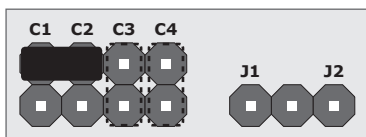

FIGURE 4

Linking function jumpers, J1 or J2, determines whether the special feature being configured is being respectively enabled or disabled.

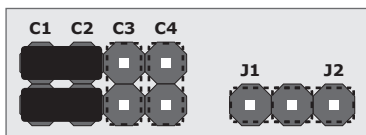

FIGURE 5

To configure a special feature, power down the receiver, fit the jumper links according to the link table on Table 14, and power up the receiver. The status LED will turn on to indicate that the new setting has been configured and saved. The link across C1 and C2, along with any other links, can now be removed. Normal receiver operation commences after the link across C1 and C2 is removed.

	Feature Enabled	Feature Disabled
Simultaneous Activation		
Sticky Latches		
Beep-on-Activation		

TABLE 14. JUMPER SETTINGS TO CONFIGURE SPECIAL FEATURES

8. SmartSwitch II Interface Capability

The Nova Helix multichannel receiver provides an interface to connect SmartSwitch II (SS II) devices to the receiver. The interface requires a common ground connection, and one signal wire. The receiver sends all the information relevant to the SmartSwitch II device over the signal wire. Figure 6 below details the wiring to connect a SmartSwitch II device to the receiver. It is inconsequential whether the SmartSwitch II device is powered from the same supply that powers the receiver, or a separate supply. All that is important is that the devices share the same ground rail.

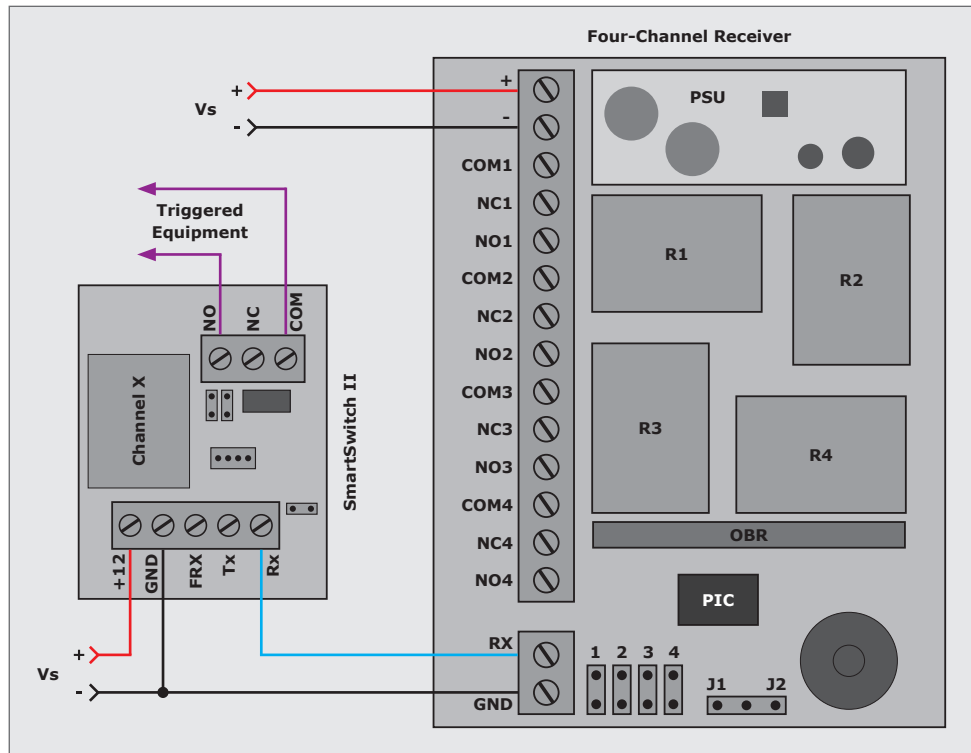

FIGURE 6. SMARTSWITCH II DEVICE WIRING

Up to 15 SmartSwitch II devices can be wired in a daisy-chained bus configuration to the receiver. SmartSwitch II devices are addressable. Each of the 15 channels that are supported on a four-channel receiver represents an address that can be used to activate a SmartSwitch II device. Figure 5 illustrates the daisy-chained topology of the SmartSwitch II bus.

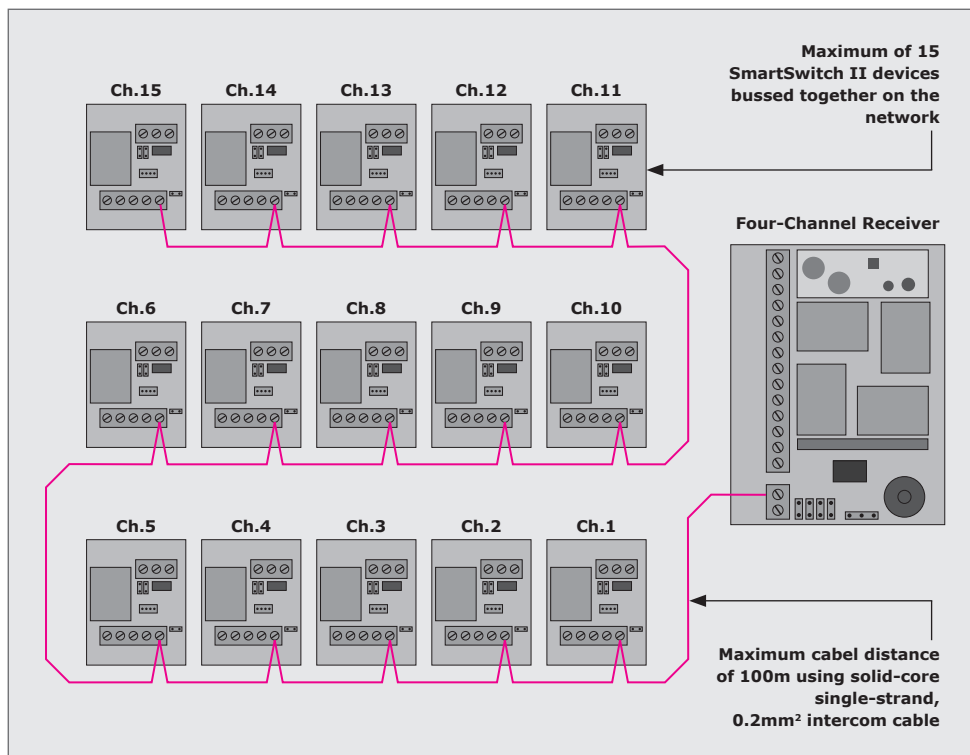

FIGURE 7. SMARTSWITCH II DEVICE NETWORK

Since the SmartSwitch II devices are addressable and the address can be configured by the user, it is possible to have multiple SmartSwitch II devices respond to the same channel. This is useful if the user would like to distribute multiple items (garden lights, for example) in physically different areas, but have all of them respond to the same remote control button activation.

The network is limited to 15 devices bussed together, over a cable distance of 100m. It is possible to provide power and signal connectivity to all 15 devices using a single conductor for each connection (supply, ground, signal), over the full 100m of network distance. Having said that, it is recommended that the power connections use at least two conductors in parallel when wiring up the SmartSwitch II network. This will ensure the bus voltage remains stable, regardless of the current drawn over the network.

9. Appendices

9.1. Appendix A - LED and Buzzer Indication Diagrams

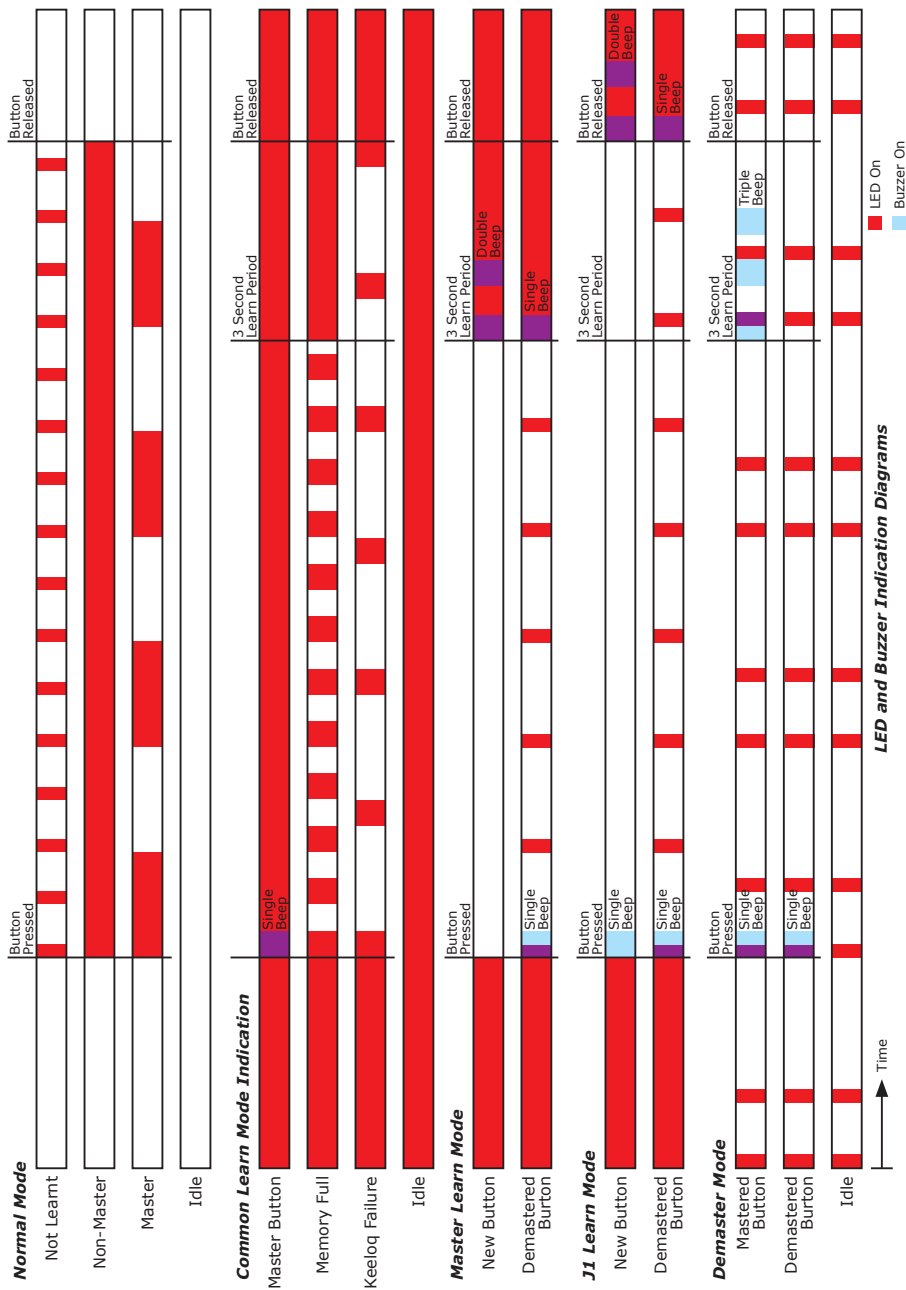

9.2. Example Autolearn Configuration Procedure



9.3. Appendix C - Example of Nova Helix Output Logic



In the example, button 2 on the Tx is pushed. The receiver, receives the signal, and captures the transmitter information. The receiver logic, processes the information, and determines that channel 3 must be activated.

The signal splitter in the output logic block, routes information to BOTH the channel 3 driver and the SmartSwitch II packetiser. This means that the relay outputs on the board are simultaneously activated with the SmartSwitch II device that is triggered.

The binary decoder, decides the channel number into binary bit information that is used to activate the relevant relay outputs. In this case, relay outputs 1 and 2. The channel output drivers fetch the output information (pulse/latch, and pulse time) from the channel settings stored in memory.

The SmartSwitch II packetiser, packages the channel information to activate the correct SmartSwitch II device. In this case, the packetiser, fetches the relevant channel information (pulse/latch and pulse time) from the channel settings stored in memory.

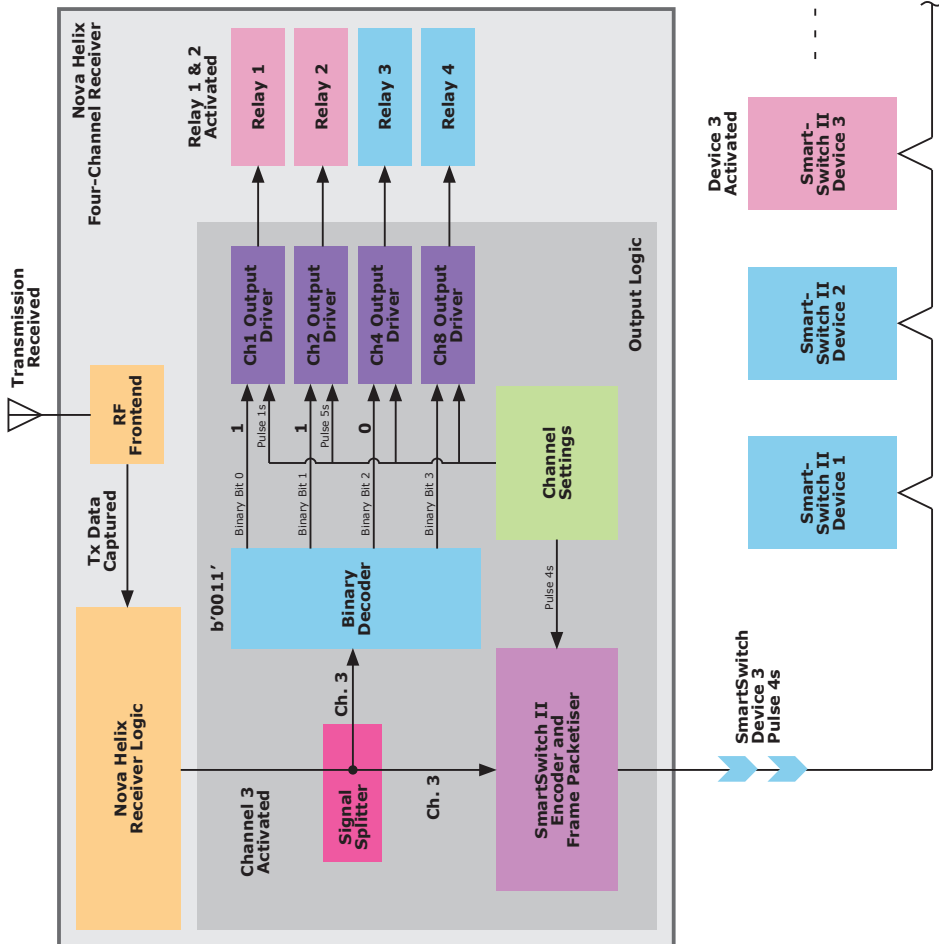



Connect with us on:

 facebook.com/centurionsystems

 YouTube.com/centurionsystems

 [@askcenturion](https://twitter.com/askcenturion)

Subscribe to the newsletter: www.centsys.com/subscribe

**Call Centurion Systems (Pty) Ltd • South Africa
Head Office: +27 11 699 2400**

**Call Technical Support: +27 11 699 2481
Monday to Friday: from 07h00 to 18h00 (GMT+2)
Saturday: from 08h00 to 16h30 (GMT+2)**

E&OE Centurion Systems (Pty) Ltd reserves the right to change any product without prior notice

All product and brand names in this document that are accompanied by the ® symbol are registered trademarks in South Africa and/or other countries, in favour of Centurion Systems (Pty) Ltd, South Africa.

The CENTURION and CENTSYS logos, all product and brand names in this document that are accompanied by the TM symbol are trademarks of Centurion Systems (Pty) Ltd, in South Africa and other territories; all rights are reserved.

We invite you to contact us for further details.



Doc number: XXXXXXXXX
SAP code: XXXXXXXXX

www.centsys.com