

Run

Sliding Gate Opener

RUN2500i

CE

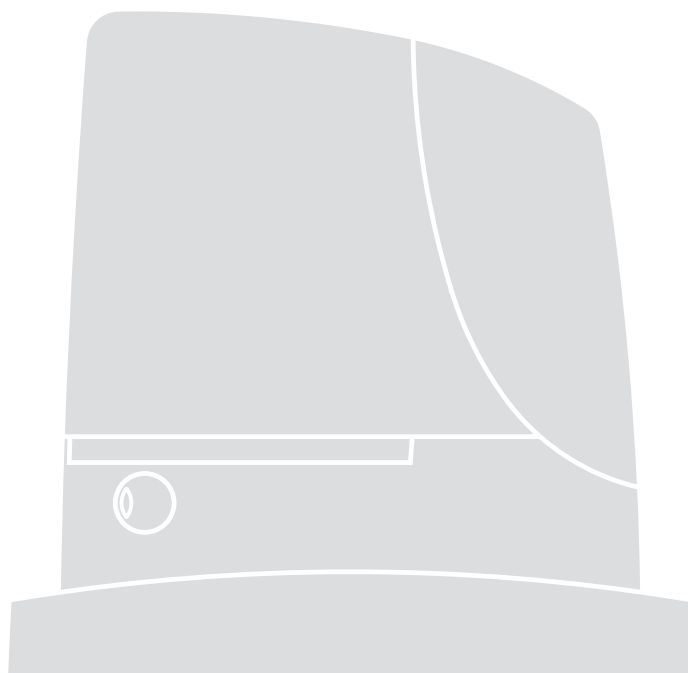

Instructions and warnings for the fitter

Run 2500i

Table of contents:

page

1	Warnings	3	7.2.1	Level one functions (ON-OFF functions)	13
2	Product description and applications	4	7.2.2	Level one programming (ON-OFF functions)	14
2.1	Operating limits	4	7.2.3	Level two functions (adjustable parameters)	14
2.2	Typical system	6	7.2.4	Level two programming (adjustable parameters)	15
2.3	List of cables	6	7.2.5	Level one programming example (ON-OFF functions)	16
3	Installation	7	7.2.6	Level two programming example (adjustable parameters)	16
3.1	Preliminary checks	7	7.3	Adding or removing devices	16
3.2	Installation of the gearmotor	7	7.3.1	BlueBUS	16
3.3	Fixing of the limit switch bracket on versions with inductive limit switch	8	7.3.2	STOP input	17
3.4	Installation of the various devices	9	7.3.3	Photocells	17
3.5	Electrical connections	9	7.3.4	FT210B Photo-sensor	17
3.6	Description of the electrical connections	10	7.3.5	RUN in "Slave" mode	18
4	Final checks and start up	10	7.3.6	Self-learning Other Devices	19
4.1	Choosing the direction	10	7.4	Special functions	19
4.2	Power supply connection	10	7.4.1	"Always open" Function	19
4.3	Device self-learning	10	7.4.2	"Move anyway" function	19
4.4	Leaf length self-learning	11	7.4.3	Heating and cooling control system	19
4.5	Checking gate movements	11	7.4.4	Maintenance warning	19
4.6	Preset functions	11	7.5	Connection of Other Devices	20
4.7	Radio receiver	11	7.6	Troubleshooting	21
5	Testing and commissioning	11	7.6.1	Malfunctions archive	21
5.1	Testing	12	7.7	Diagnostics and signals	21
5.2	Commissioning	12	7.7.1	Flashing light signalling	22
6	Maintenance and Disposal	12	7.7.2	Signals on the control unit	22
6.1	Maintenance	12	7.8	Accessories	23
6.2	Disposal	12	7.8.1	Remote programming unit	23
7	Additional information	13	8	Technical characteristics	24
7.1	Programming keys	13		Instructions and Warnings for users of RUN gearmotor	25
7.2	Programming	13			

1) Warnings

This manual contains important information regarding safety. Before starting installation of the components, it is important that you read all the information contained herein. Store this manual safely for future use. Due to the dangers which may arise during both the installation and use of the RUN, installation must be carried out in full observance of the laws, provisions and rules currently in force to ensure maximum safety. This chapter provides details of general warnings. Other more specific warnings are detailed in Chapters “3.1 Preliminary Checks” and “5 Testing and Commissioning”.

⚠ According to the most recent European legislation, the automation of doors or gates is governed by the provisions listed in Directive 98/37/CE (Machine Directive) and, more specifically the standards: EN 13241-1 (harmonised standard); EN 12445; EN 12453 and EN 12635, which enables the declaration of machine conformity to the machine directive.

Visit “www.niceforyou.com” for further information and guidelines for risk analysis and how to draw up the Technical Documentation. This manual has been especially written for use by qualified fitters. Except for the enclosed specification “Instructions and Warnings for Users of the RUN gearmotor” to be removed by the installer, none of the information provided in this manual can be considered as being of interest to the end users!

- Any use or operation of RUN not explicitly provided for in these instructions is not permitted. Improper use may cause damage and personal injury.
- A risk analysis must be carried out before starting installation, including a the list of essential safety requisites provided for in Enclosure I of the Machine Directive, indicating the relative solutions employed. N.B. Risk analysis is one of the documents included in the “Technical Documentation” for this automation.
- Check whether additional devices are needed to complete the automation with RUN based on the specific application requirements and dangers present. The following risks must be considered: impact, crushing, shearing, dragging, etc. as well as other general dangers.
- Do not modify any components unless such action is specified in this manual. Operations of this type are likely to lead to malfunctions. NICE disclaims any liability for damage resulting from modified products.
- During installation and use, ensure that solid objects or liquids do not penetrate the control unit or other open devices. If necessary, contact the NICE customer service department; use of RUN in these conditions can be dangerous.
- The automation system must not be used until it has been commissioned as described in chapter 5 “Testing and commissioning”.
- The RUN packaging materials must be disposed of in compliance with local regulations.
- If a fault occurs that cannot be solved using the information provided in this manual, contact the NICE customer service department.
- In the event that any automatic switches are tripped or fuses blown, attempt to identify and eliminate the relative fault.
- Disconnect all the power supply circuits before accessing the terminals inside the RUN cover. If the disconnection device is not identifiable, affix the following sign: “WARNING: MAINTENANCE WORK IN PROGRESS”.

Special warnings concerning the suitable use of this product in relation to the 98/37CE “Machine Directive” (ex 89/392/CEE):

- This product is issued on the market as a “machine component” and is therefore manufactured to be integrated in a machine or assembled with other machines in order to create “a machine”, in accordance with the directive 98/37/EC, exclusively in combination with other components and in the manner described in the present instructions manual. As specified in the directive 98/37CE the use of this product is not admitted until the manufacturer of the machine on which this product is mounted has identified and declared it as conforming to the directive 98/37/CE.

Special warnings concerning suitable use of this product in relation to the 73/23/EEC “Low Voltage” Directive and subsequent amendments 93/68/CEE:

- This product complies with the provisions envisaged by the “Low Voltage” Directive if used in the configurations foreseen in this instruction manual and in combination with the articles present in the Nice S.p.a. product catalogue. If the product is not used in the specified configurations or is used with other products that have not been foreseen, the requirements may not be guaranteed; use of the product is prohibited in these conditions until compliance with the requirements foreseen by the directive has been verified by installers.

Special warnings concerning suitable use of this product in relation to the 89/336/EEC “Electromagnetic Compatibility” Directive and subsequent amendments 92/31/EEC and 93/68/EEC:

- This product has undergone tests regarding electromagnetic compatibility in the most critical of use conditions, in the configurations foreseen in this instruction manual and in combination with articles present in the Nice S.p.A. product catalogue. Electromagnetic compatibility may not be guaranteed if used in configurations or with other products that have not been foreseen; use of the product is prohibited in these conditions until compliance with the requirements foreseen by the directive has been verified by installers.

2) Product description and applications

RUN is a range of irreversible electromechanical gearmotors used for the automation of sliding gates. They are equipped with an electronic control unit and an "SM" type connector for radio control receivers (optional). Electrical connections to external devices are facilitated thanks to the use of the "BlueBUS" system, which enables the connection of several devices by means of just 2 wires. The list of devices compatible for connection to the Run BlueBUS is given in chapter 7.3.1 "BlueBUS"; an updated list, with relative compatibility

is also available at: www.niceforyou.com. RUN is equipped with a connector for remote programming units to enable complete and quick management of installation, maintenance, troubleshooting of any malfunctions; refer also to 7.8.1 "Remote programming unit". RUN is electrically powered, in the event of a power failure, the device can be released by means of the special key, to enable manual movement of the gate.

Other products are also part of the RUN range, the difference of which is described in table 1.

Table 1: comparison of the RUN gearmotor main characteristics

Gearmotor type				RUN2500i
Limit switch type				electromechanical
Maximum leaf length				18m
Maximum leaf weight				2500Kg
Peak thrust (corresponding to a force)				50Nm (1660N)
Motor				Three phase maximum 650 Watt

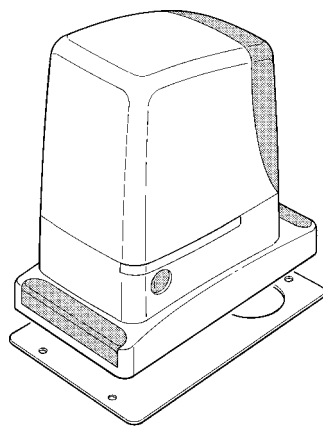

1

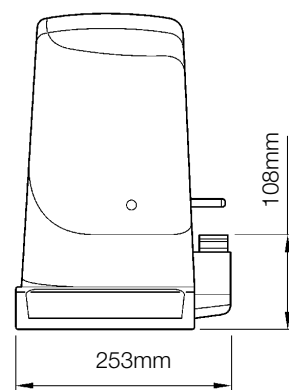
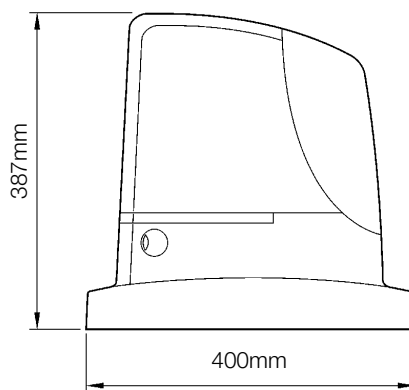

2.1) Operating limits

Chapter 8 "Technical Characteristics" provides the only data needed to determine whether the products of the RUN line are suitable for the intended application. The structural characteristics of RUN make it suitable for use on sliding leaves in conformity with the limits specified in tables 2, 3 and 4.

The effective suitability of RUN to automate a sliding gate depends on friction and other factors, even occasional, such as the presence of ice which could obstruct leaf movement. To ensure suitability, it is absolutely vital to measure the force necessary to move the leaf throughout its entire run and ensure that this is less than half of the "nominal torque" indicated in chapter 8 "Technical characteristics" (a 50% margin on the force is recommended, as unfavourable climatic conditions may cause an increase in the friction); furthermore, the

data specified in tables 2 and 3 should be taken into account to establish the number of cycles/hour and consecutive cycles.

Table 2: limits in relation to the length of the leaf

Leaf width(m)	RUN2500i		
			max. consecutive cycles
Up to 6			56

Table 3: limits in relation to the weight of the leaf

Leaf weight (kg)	RUN2500i	
	Cycle percentage	
Up to 500	100%	
500 ÷ 900	80	
900 ÷ 1200	75	
1200 ÷ 1500	60	
1500 ÷ 1800	50	
2000 ÷ 2300	40	
2300 ÷ 2500	30	

The length of the leaf enables the calculation of both the maximum number of cycles per hour and consecutive cycles, while the weight enables the calculation of the percentage of cycle reduction and the maximum speed allowed. For example, for RUN1800 if the leaf is 10 m long it will be possible to have 21 cycles/hour and 14 consecutive cycles. However, if the leaf weighs 1300 Kg, they must be reduced by 60 %, resulting in 9 cycles/hour and 8 consecutive cycles. The control unit has a limiting device which prevents the risk of overheating based on the load of the motor and duration of the cycles. This device triggers when the maximum limit is exceeded. The manoeuvre limiting device also measures the ambient temperature reducing the number of manoeuvres further when the temperature is particularly high.

The “durability” estimate is shown in chapter 8 “Technical characteristics”, which is the average useful life of the product. The value is strongly influenced by the severity index of the manoeuvre, this being the sum of all factors that contribute to wear. To make this estimate, all severity indexes in table 4 must be added together, and the result should be used to check estimated durability in the graph.

For example: for RUN1800 on a gate weighing 1300 Kg and 10 m in length, equipped with photocells and other stress related elements obtains a severity index equal to 45% (20+15+10). From the graph the estimated durability is equal to 200.000 cycles.

Note that the estimated durability is calculated on the basis of design specifications and the results of tests performed on prototypes; as this is an estimate only, it does not represent any form of guarantee on the effective durability of the product.

Table 4: durability estimate in relation to the manoeuvre severity index

Severity index %	Run		Durability in cycles	
	2500i			
Leaf weight kg				
Up to 500		5		
500 ÷ 900		10		
900 ÷ 1200		20		
1200 ÷ 1500		30		
1500 ÷ 1800		40		
1800 ÷ 2200		50		
2200 ÷ 2500		60		
Leaf length m				
Up to 6		5		
6 ÷ 9		10		
9 ÷ 12		15		
12 ÷ 15		25		
15 ÷ 18		35		
Other stress related elements (to be taken into consideration if the probability is greater than 10%)				
Ambient temperature greater than 40°C or lower than 0°C or humidity greater than 80%		10		
Presence of dust and sand		15		
Presence of salinity		20		
Photo manoeuvre interruption		10		
Stop manoeuvre interruption		20		
Thrust active		10		
Severity index total%:				

Note: if the index of severity exceeds 100% this means that the conditions are outside the limits of acceptability; in this case the use of a larger-sized model is recommended.

2.2) Typical system

Figure 2 shows a typical system for automating a sliding gate using RUN.

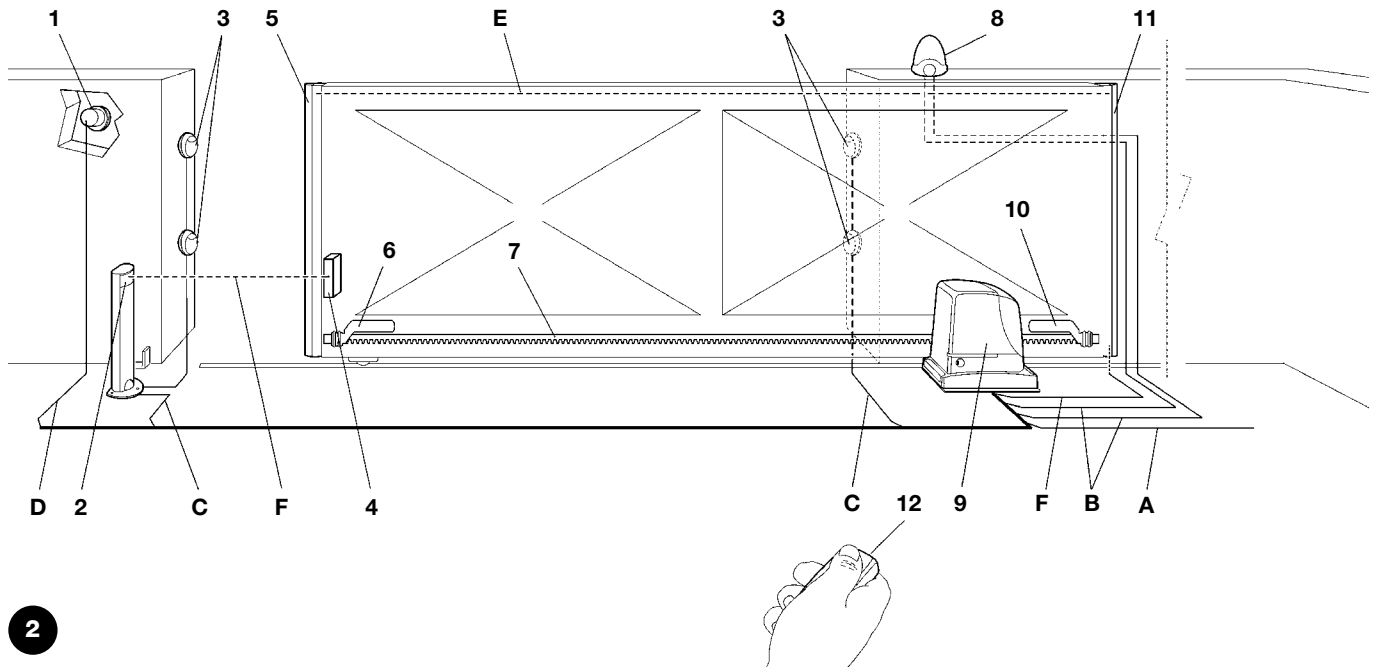

2

- | | |
|--------------------------------|---|
| 1 Key-operated selector switch | 7 Rack |
| 2 Receiver FT210B | 8 Flashing light with incorporated aerial |
| 3 Photocells | 9 RUN |
| 4 Transmitter FT210B | 10 "Closed" limit switch bracket |
| 5 Primary movable edge | 11 Primary movable edge (optional) |
| 6 "Open" limit switch bracket | 12 Radio transmitter |

2.3) List of cables

The typical system shown in figure 2 also states the cables required for connection of the various devices, the specifications of which are provided in table 5.

⚠ The cables used must be suitable for the type of installation; for example, an H03VV-F type cable is recommended for indoor applications, while H07RN-F is suitable for outdoor applications.

Table 5: List of cables

Connection	Cable type	Maximum admissible length
A: Electrical power line	N°1 cable 3x1,5mm ²	30m (note 1)
B: Flashing light with aerial	N°1 cable 2x0,5mm ²	20m
	N°1 shielded cable type RG58	20m (less than 5m recommended)
C: Photocells	N°1 cable 2x0,5mm ²	30m (note 2)
D: Key-operated selector switch	N°2 cable 2x0,5mm ² (note 3)	50m
E: Connection between 2 movable edges	N°1 cable 2x0,5mm ² (note 4)	20m
F: Movable edge connection	N°1 cable 2x0,5mm ² (note 5)	30m

Note 1: power supply cable longer than 30 m may be used provided it has a larger gauge, e.g. 3x2,5mm², and that a safety earthing system is provided near the automation unit.

Note 2: If the "BLUEBUS" cable is longer than 30 m, up to 50 m, a 2x1mm² cable is needed.

Note 3: A single 4x0,5mm² cable can be used instead of two 2x0,5mm² cables.

Note 4: Refer to Chapter "7.3.2 STOP Input" in situations where there is more than one edge, for information about the type of connection recommended by the manufacturer.

Note 5: special devices which enable connection even when the leaf is moving must be used to connect movable edges to sliding leaves; con l'anta in movimento; nella figura è indicato l'utilizzo di FT210B.

3) Installation

⚠ The installation of RUN must be carried out by qualified personnel in compliance with current legislation, standards and regulations, and the directions provided in this manual.

3.1) Preliminary checks

Before proceeding with the installation of RUN:

- Check that all the materials are in excellent condition, suitable for use and compliant with current standards.
- Ensure that the structure of the gate is suitable for automation.
- Ensure that the weight and dimensions of the leaf fall within the specified operating limits provided in chapter "2.1 Operating limits".
- Check that the force required to start the movement of the leaf is less than half the "maximum torque", and that the force required to keep the leaf in movement is less than half the "nominal torque". Compare the resulting values with those specified in Chapter "8 Technical Characteristics". The manufacturers recommend a 50% margin on the force, as unfavourable climatic conditions may cause an increase in the friction.
- Ensure that there are no points of greater friction in the opening or closing travel of the gate leaves.
- Ensure there is no danger of the gate derailing.
- Ensure that the mechanical stops are sufficiently sturdy and that there is no risk of deformation even when the leaf hits the mechanical stop violently.
- Ensure that the gate is well balanced: it must not move by itself when it is placed in any position.
- Ensure that the area where the gearmotor is fixed is not subject to flooding. If necessary, mount the gearmotor raised from the ground.
- Ensure that the installation area enables the release of the gearmotor and that it is safe and easy to release it.
- Ensure that the mounting positions of the various devices are protected from impact and that the mounting surfaces are sufficiently sturdy.
- Components must never be immersed in water or other liquids.
- Keep RUN away from heat sources and open flames; in acid, saline or potentially explosive atmosphere; this could damage RUN and cause malfunctions or hazardous situations.
- If there is an access door in the leaf, or within the range of movement of the gate, make sure that it does not obstruct normal travel. Mount a suitable interlock system if necessary.
- Only connect the control unit to a power supply line equipped with a safety grounding system.
- The power supply line must be protected by suitable magneto-thermal and differential switches.
- A disconnection device must be inserted in the power supply line from the electrical mains (the distance between the contacts must be at least 3.5 mm with an overvoltage category of III) or equivalent system, for example an outlet and relative plug. If the disconnection device for the power supply is not mounted near the automation, it must have a locking system to prevent unintentional, unauthorised connection.

3.2) Installation of the gearmotor

The gearmotor must be secured directly to an already existing mounting surface using suitable means, for example expansion bolts. Otherwise, in order to fasten the gearmotor the installer must:

1. Dig a foundation hole with suitable dimensions referring to Figure 3.
2. Prepare one or more conduits for the electrical cables as shown in figure 4.
3. Assemble the 4 clamps on the foundation plate setting one nut underneath and one on top of the plate. The nut underneath the plate must be tightened as shown in Figure 5 so that the threaded part protrudes above the plate by max. 40 mm.

4. Pour the concrete and, before it starts to harden, set the foundation plate to the values shown in Figure 3. Check that it is parallel to the leaf and perfectly level (Figure 6). Wait for the concrete to harden completely.
5. Remove the 4 upper nuts on the plate and then position the gearmotor. Check that it is perfectly parallel to the leaf, then refit and tighten the four nuts and washers supplied, as shown in Figure 7.

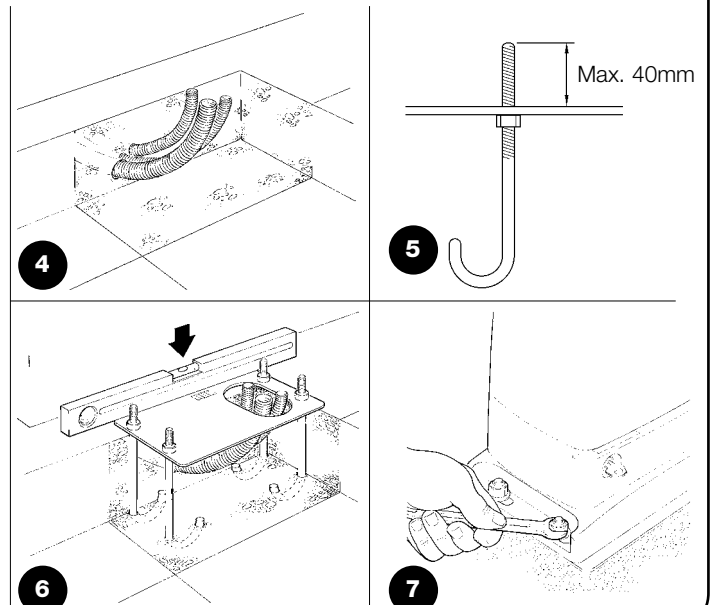
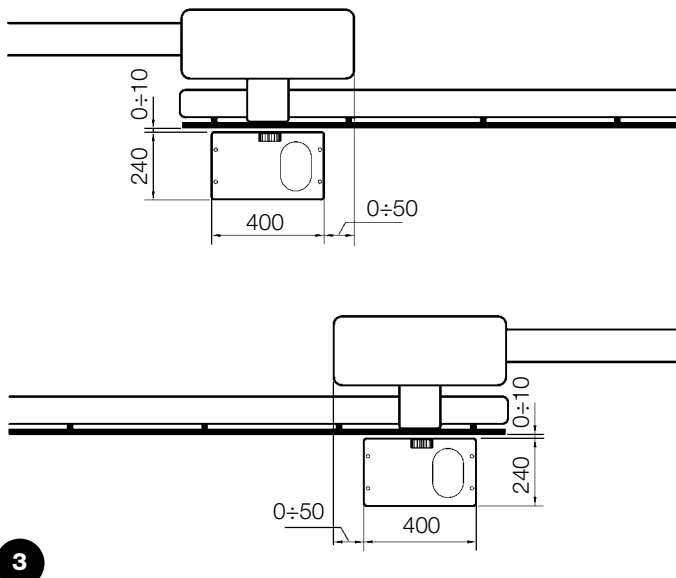

6. Release the gearmotor as shown in “Release and manual movement” paragraph in the Chapter “Instructions and Warnings for users of the RUN gearmotor”.
7. Open the leaf up completely and place the first piece of the rack on the pinion. Check that the beginning of the rack corresponds to the beginning of the leaf, as shown in Figure 8. Leave 1±2 mm play between the rack and the pinion, then fasten the rack to the leaf using suitable means.

⚠ In order to prevent the weight of the leaf from affecting the gearmotor, it is important that there is a play of 1±2 mm between the rack and the pinion as shown in Figure 9.

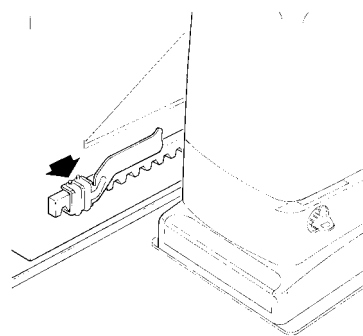
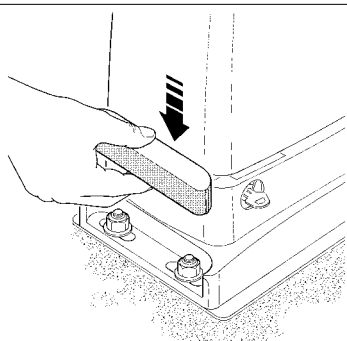
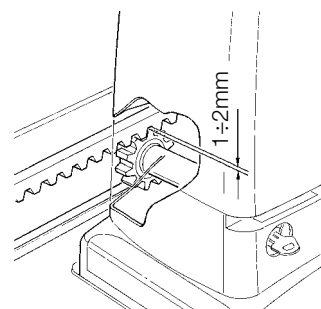
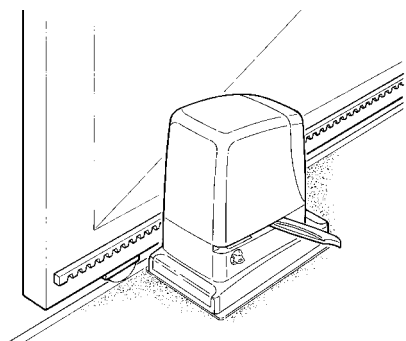

8. Slide the leaf, using the pinion as a reference point for the securing the other elements of the rack.
9. Cut away the excess section of the rack.
10. Open and close the gate several times and make sure that the rack is aligned with the pinion with a maximum tolerance of 5 mm. Moreover, check that the play of 1±2 mm has been respected along the entire length between the pinion and the rack.
11. Thoroughly tighten the two fixing nuts of the gearmotor making sure it is well secured to the ground. Cover the fixing nuts with the relative caps as shown in figure 10.
12. Fix the limit switch bracket as described below (for versions RUN1800P and RUN2500P, fix the bracket as described in para-

graph “3.3 Fixing of the limit switch bracket on versions with inductive limit switch”):

- Manually place the leaf in the open position leaving at least 2-3 cm from the mechanical stop.
 - Slide the bracket along the rack in the opening direction until the limit switch cuts-in. Then bring the bracket forward by at least 2 cm and secure it to the rack with the appropriate stud bolts, as shown in fig. 11.
 - Perform the same operation for the closure limit switch.
13. Secure the gearmotor as described in the paragraph “Release and manual movement” in the Chapter “Instructions and Warnings for Users”.

3.4) Installation of the various devices

If other devices are required, install them following the directions provided in the corresponding instructions. Check this in paragraph "3.6 Description of electrical connections" and the devices which can be connected to the RUN in Figure 2.

3.5) Electrical connections

⚠ Only carry out electrical connections once the electricity supply to the system has been switched off.

1. Remove the protection cover in order to access the electronic control unit of the RUN. The side screw must be removed, and the cover lifted upwards.
2. Remove the rubber membrane sealing off the two holes for routing the cables; insert the power cable in the smaller hole and all other cables for the various devices in the larger hole, leaving a length of 20÷30 cm longer than necessary. See Table 5 for information regarding the type of cables and Figure 2 for the connections.
3. Use a clamp to collect together and join the cables routed through the larger hole and place the clamp under the cable entry hole. Make a hole in the rubber membrane which is slightly smaller than

the diameter of the cables joined by the clamp, and slide the membrane along the cables until it reaches the clamp. Then put the membrane back in its seat. Place a second clamp for collecting the cables which are set just above the membrane.

4. On the smaller membrane, cut a hole slightly smaller than the diameter of the power cable and slide the membrane along the cable until it fits into its seat.
5. Connect the power cable to the relative terminal as shown in figure 14, and secure the cable by means of the collar.
6. Connect up the other cables according to the diagram in Figure 16. The terminals can be removed in order to facilitate this procedure.
7. Once the connections have been completed, secure the cables joined in the clamps to the cable locking rings. The excess aerial cable must be secured to the other cables using another clamp as shown in Figure 15.

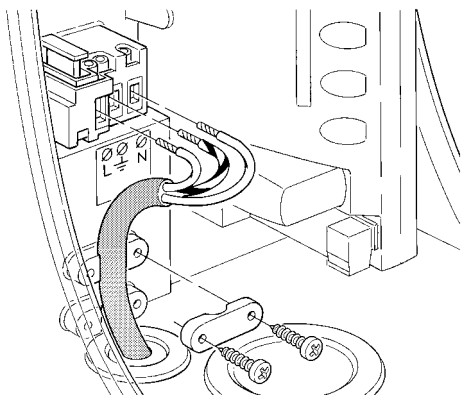

14

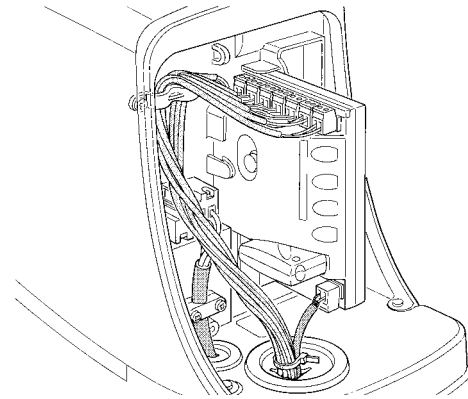

15

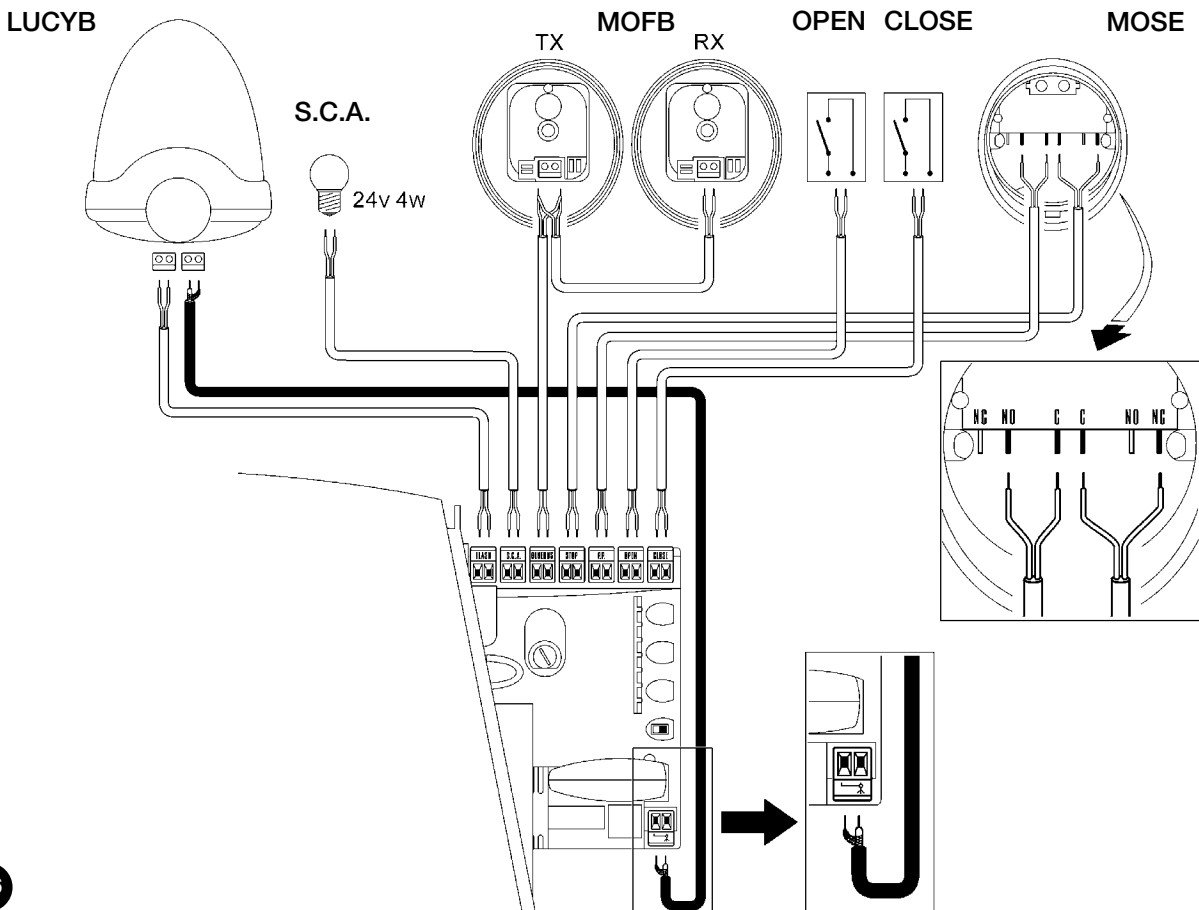

16

See paragraph "7.3.5 RUN in Slave mode" for the connection of 2 motors on opposite leaves.

3.6) Description of the electrical connections

The following is a brief description of the electrical connections; for further information please read "7.3 Adding or Removing Devices" paragraph.

FLASH: output for one or two "LUCYB" or similar type flashing lights with single 12V maximum 21W bulb.

S.C.A.: "Open Gate Indicator" output. An indicator lamp can be connected (24V max. 4W). It can also be programmed for other functions; see paragraph "7.2.3 Level two functions"

BLUEBUS: compatible devices can be connected up to this terminal. They are connected in parallel using two wires only, through which both the electricity supply and the communication signals travel. For more useful information about BlueBUS see also Paragraph "7.3.1 BlueBUS".

STOP: input for the devices which block or eventually stop the manoeuvre in progress. Contacts like "Normally Closed", "Normally Open" or constant resistance devices can be connected up using

special procedures on the input. For more useful information about STOP see also Paragraph "7.3.2 STOP Input".

STEP-BY-STEP: input for devices which control Step-by-Step movement. It is possible to connect "Normally Open" devices up to this input.

OPEN: input for devices which control only the opening movement. It is possible to connect "Normally Open" devices up to this input.

CLOSE: input for devices which control only the closing movement. It is possible to connect "Normally Open" devices up to this input.

AERIAL: connection input for the radio receiver aerial (the aerial is incorporated in LUCY B).

4) Final checks and start up

The manufacturers recommend positioning the leaf at approximately mid-stroke before starting the checking and start up phase of the automation. This will ensure the leaf is free to move both during opening and closure.

4.1) Choosing the direction

The direction of the opening manoeuvre must be chosen according to the position of the gearmotor with respect to the leaf. If the leaf must move to the left for opening, the selector must be moved towards left as shown in Figure 17; alternatively, if the leaf has to move to the right during opening, the selector must be moved towards the right as shown in Figure 18.

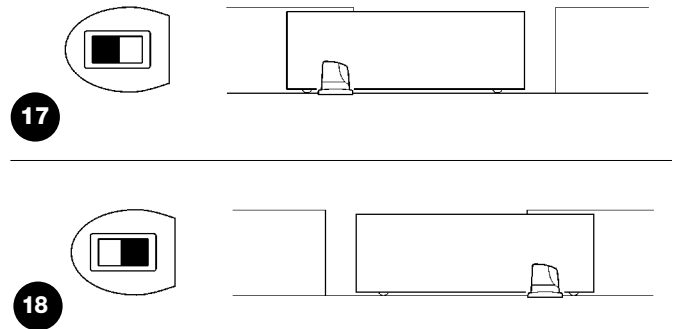

4.2) Power supply connection

⚠ The connection of RUN to the mains must be made by qualified and experienced personnel in possession of the necessary requisites and in full observance of current laws, provisions and standards.

As soon as RUN is powered up, check the following:

1. Ensure that the "BLUEBUS" LED flashes regularly, with about one flash per second.
2. Ensure that the LED's on the photocells flash (both on TX and RX); the type of flashing is not important as it depends on other factors.

3. Ensure that the flashing light connected to the FLASH output and the lamp LED connected to the "Open Gate Indicator" output are off.

If the above conditions are not satisfied, immediately switch off the power supply to the control unit and check the electrical connections more carefully. Please refer to Chapter "7.6 Troubleshooting" for further information about fault-finding and analysis.

4.3) Device self-learning

After connecting up the power supply, the control unit must "learn" the devices connected up to the BLUEBUS and STOP inputs. Before this phase, LEDs L1 and L2 will flash to indicate that device self-learning must be carried out.

1. Press and hold keys **[▲]** and **[Set]**
2. Release the keys when leds L1 and L2 start flashing very quickly (after approx. 3 s)
3. Wait a few seconds for the control unit to finish self-learning the devices
4. When the self-learning stage is complete, the STOP LED must remain on while L1 and L2 must turn off (leds L3 and L4 will eventually start flashing).

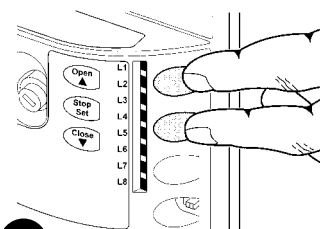

The connected devices self-learning stage can be repeated at any time, even after the installation (for example, if a new device is installed); to repeat self-learning see paragraph "7.3.6 Self-learning Other Devices".

4.4) Leaf length self-learning

After self-learning the devices, leds L3 and L4 start flashing; the control unit must self-learn the length of the gate. During this stage, the length of the leaf is measured from the closing limit switch to the opening limit switch. This measurement is required to calculate the deceleration points and the partial opening point.

1. Press and hold keys [▼] and [Set]
2. Release the keys when the manoeuvre starts (after approx. 3 s)
3. Check the manoeuvre in progress is an opening manoeuvre. Otherwise, press the [Stop] key and carefully check Paragraph "4.1 Choosing the Direction", then repeat the process from Point 1.
4. Wait for the control unit to open the gate until it reaches the opening limit switch; the closing manoeuvre will start immediately afterwards.
5. Wait for the control unit to close the gate.

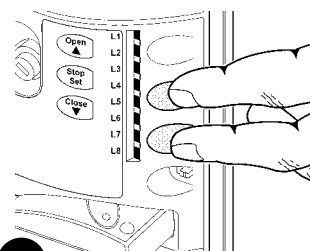

20

If the above conditions are not satisfied, immediately switch off the power supply to the control unit and check the electrical connections more carefully. For more useful information see also chapter "7.6 Troubleshooting".

4.5) Checking gate movements

On completion of self-learning of the length of the leaf, a number of manoeuvres should be carried out to ensure correct gate travel

1. Press the [Open] key to open the gate. Check that gate opening occurs regularly, without any variations in speed. The leaf must only slow down and stop when it is between 70 and 50 cm from the opening mechanical stop. Then, at 2÷3 cm from the mechanical opening stop the limit switch will trigger.
2. Press the [Close] key to close the gate. Check that gate closing occurs regularly, without any variations in speed. The leaf must only slow down and stop when it is between 70 and 50 cm from the closing mechanical stop. Then, at 2÷3 cm from the mechanical closing stop the limit switch will trigger.
3. During the manoeuvre, check that the flashing light flashes at a speed of 0.5 seconds on and 0.5 seconds off. If present, also check the flashes of the light connected to the open gate indicator terminal: slow flashes during opening, quick flashes during closing.
4. Open and close the gate several times to make sure that there are no points of excessive friction and that there are no defects in the assembly or adjustments.
5. Check that the fixture of the RUN gearmotor, the rack and the limit switch brackets are solid, stable and suitably resistant, even if the gate accelerates or decelerates sharply.

4.6) Preset functions

The RUN control unit has a number of programmable functions. These functions are set to a configuration which should satisfy most automations. However, the functions can be modified at any time by means of a special programming procedure.

Please refer to paragraph "7.2 Programming" for further information.

4.7) Radio receiver

An "SM" connector for SMXI or SMXIS type optional radio receivers is fitted on the control unit to enable remote control of RUN. Disconnect the power supply and follow the operations indicated in fig. 21 to install the radio receiver. The association between the SMXI and SMXIS radio receiver output and the command performed by RUN is described in table 6:

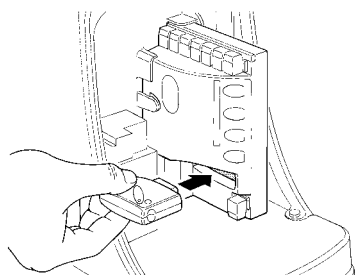

21

For further information, consult the radio receiver instruction manual.

Table 6: commands with transmitter

Output N°1	STEP-BY-STEP command
Output N°2	"Partial opening" command
Output N°3	"Open" command
Output N°4	"Close" command

5) Testing and commissioning

This is the most important stage in the automation system installation procedure in order to ensure maximum safety levels. Testing can also be adopted as a method of periodically checking that all the various devices in the system are functioning correctly.

⚠ Testing of the entire system must be performed by qualified and experienced personnel who must establish which tests to conduct on the basis of the risks involved, and verify the compliance of the system with applicable regulations, legislation and standards, in particular with all the provisions of EN standard 12445 which establishes the test methods for automation systems for gates.

5.1) Testing

Each component of the system, e.g. safety edges, photocells, emergency stop, etc. requires a specific testing phase. We therefore recommend observing the procedures shown in the relative instruction manuals. To test RUN, proceed as follows:

1. Ensure that the instructions outlined in this manual and in particular in chapter 1 "WARNINGS" have been observed in full;
2. Release the gearmotor as shown in "Release and manual movement" paragraph in chapter "Instructions and Warnings for users of the RUN gearmotor"
3. Make sure you can move the door manually both during opening and closing with a force of max. 390N (40 kg approx.).
4. Lock the gearmotor.
5. Using the control or stop devices (key-operated selector switch, control buttons or radio transmitter) test the opening, closing and

stopping of the gate and make sure that the leaves move in the intended direction.

6. Ensure correct operation of all safety devices, one by one (photocells, sensitive edges, emergency stop, etc.) and check that the gate performs as it should. In particular, each time a device is activated the "BlueBUS" LED on the control unit flashes 2 times quickly, confirming that the control unit recognizes the event.
7. If the hazardous situations caused by the movement of the leaf have been safeguarded by limiting the force of impact, the impact force must be measured according to EN Standard 12445. If the adjustment of the "obstacle detection sensitivity" and control of the "motor torque" are used to assist the system for the reduction of the impact force, try to find the adjustment to obtain optimal results.

5.2) Commissioning

Commissioning can take place only after all the testing phases of the RUN and the other devices have been completed successfully. It is not permissible to execute partial commissioning or to enable use of the system in makeshift conditions.

1. Prepare and store for at least 10 years the technical documentation for the automation, which must include at least the following: assembly drawing of the automation, wiring diagram, analysis of hazards and solutions adopted, manufacturer's declaration of conformity of all the devices installed (for RUN use the annexed CE declaration of conformity); copy of the instruction manual and maintenance schedule of the automation.
2. Affix a dataplate on the gate providing at least the following data: type of automation, name and address of manufacturer (person responsible for the "commissioning"), serial number, year of manufacture and "CE" marking.

3. Post a permanent label or sign near the gate detailing the operations for the release and manual manoeuvre.
4. Prepare the declaration of conformity of the automation system and deliver it to the owner.
5. Prepare the "Instructions and warnings for the use of the automation system" and deliver it to the owner.
6. Prepare the maintenance schedule of the automation system and deliver it to the owner; this must provide all directions regarding the maintenance of the single automation devices.
7. Before commissioning the automation system inform the owner in writing regarding residual risks and hazards (e.g. in the "Instructions and warnings for the use of the automation system").

6) Maintenance and Disposal

This charter provides information about how to draw up a maintenance schedule, and the disposal of RUN.

6.1) Maintenance

The automation must undergo maintenance work on a regular basis, in order to guarantee prolonged lifetime; to this end RUN has a manoeuvre counter and maintenance warning system; see paragraph "7.4.4 Maintenance warning".

⚠ The maintenance operations must be performed in strict compliance with the safety directions provided in this manual and according to the applicable legislation and standards.

If other devices are present, follow the directions provided in the corresponding maintenance schedule.

1. RUN requires scheduled maintenance work every 6 months or 20,000 manoeuvres (max.) after previous maintenance.
2. Disconnect all power supplies.
3. Check for any deterioration of the components which form the automation, paying particular attention to erosion or oxidation of the structural parts. Replace any parts which are below the required standard.
4. Check the wear and tear on the moving parts: pinion, rack and the leaf components; if necessary replace.
5. Connect the electric power sources up again, and carry out the testing and checks stated in Paragraph "5.1 Testing".

6.2) Disposal

As in the case of installation, at the end of the product lifetime, disposal procedures must be carried out by qualified personnel. This product comprises various types of materials, some of which can be recycled while others must be disposed of. Check information on the recycling and disposal procedures according to local legislation for this product category.

⚠ Some parts of the product may contain pollutant or hazardous substances; if disposed of into the environment these may constitute a serious risk of damage to the environment and public health.

As indicated by the symbol in figure 22 never dispose of this product in domestic waste. Apply classified waste collection procedures for disposal in accordance with local regulations or return the product to the retailer when purchasing a new model.



Local regulations may envisage serious fines in the event of illegal disposal of this product.

7) Additional information

Programming, personalisation and how to look for and deal with faults on the RUN will be dealt with in this chapter.

7.1) Programming keys

The RUN control unit features three keys that can be used to command the control unit both during tests and programming:

Open ▲	The "OPEN" key enables the user to control the opening of the gate or move the programming point upwards.
Stop Set	The "STOP" key enables the user to stop the manoeuvre. If pressed down for more than 5 seconds it enables the user to enter programming.
Close ▼	The "CLOSE" key enables the user to control the closing of the gate or move the programming point downwards.

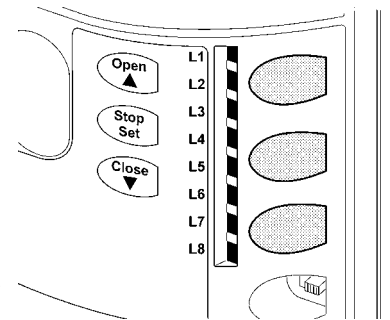

7.2) Programming

A number of programmable functions are available on the RUN control unit. The functions are adjusted using 3 keys set on the control unit: [▲] [Set] [▼] and are used by means of 8 LEDs: **L1...L8**. The programmable functions available on RUN are set out on 2 levels:

Level one: the functions can be adjusted in modes ON-OFF (active or inactive). In this case, each of the LEDs **L1...L8** indicates a function. If the LED is on, the function is active, if off the function is inactive. See Table 7.

Level two: the parameters can be adjusted on a scale of values (from 1 to 8). In this case, each of the LEDs **L1...L8** indicates the value set (there are 8 possible settings). Please refer to Table 9.

7.2.1) Level one functions (ON-OFF functions).

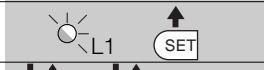



Table 7: programmable function list: level one:

Led	Function	Description
L1	Automatic Closing	This function causes the door to close automatically after the programmed time has lapsed. The factory set Pause Time is 30 seconds, but can be changed to 5, 15, 30, 45, 60, 80, 120 or 180 seconds. If the function is inactive, functioning will be "semi-automatic".
L2	Close After Photo	This function enables the gate to be kept open for the necessary transit time only. In fact the "Photo" always causes an automatic closure with a pause time of 5s (regardless of the programmed value). The action changes depending on whether the "Automatic closing" function is active or not. When "Automatic Closing" is inactive: The gate always arrives to the totally open position (even if the Photo disengages first). Automatic closing with a pause of 5s occurs when the Photo is disengaged. When "Automatic Closing" is active: The opening manoeuvre stops immediately after the photocells have disengaged. After 5 seconds, the gate will begin to close automatically. The "Close after photo" function is always disabled in manoeuvres interrupted by a Stop command. If the "Close after photo" function is inactive the pause time is that which has been programmed or there is no automatic closing if the function is inactive.
L3	Always Close	The "Always Close" function is activated, causing closure when an open gate is detected on return of power. A light will flash for 5 seconds before the manoeuvre starts, for safety purposes. If the function is inactive when the power supply returns, the gate will remain stationary.
L4	Deceleration	On activation of this function, a deceleration phase is activated at the end of the opening or closing manoeuvre. The final deceleration speed corresponds to approx. 0.05 m/s, regardless of the speed set during the manoeuvre. If deceleration is not active the speed remains constant throughout the manoeuvre. Caution: Run 2500 I maintains the same force applied during the manoeuvre also during deceleration; therefore deceleration can also be implemented on very heavyweight gates.
L5	Peak	On activation of this function, gradual acceleration at the start of each manoeuvre is disabled; this enables the maximum peak force and is useful in situations with high levels of static friction, such as in the event of snow or ice blocking the leaf. If Peak is not active the manoeuvre starts with a gradual acceleration phase.
L6	Pre-flashing	With the pre-flashing function, a 3 second pause is added between the flashing light switching on and the beginning of the manoeuvre in order to warn the user in advance of a potentially dangerous situation. If pre-flashing is inactive, the flashing light will switch on when the manoeuvre starts.
L7	"Close" becomes "Partial Open"	By activating this function all "close" commands ("CLOSE" input or radio command "close") activate a partial opening manoeuvre (see LED L6 on table 9).
L8	"Slave" mode	By activating this function RUN becomes "Slave": in this way it is possible to synchronise the functioning of two motors on opposite leaves where one motor functions as Master and the other as Slave; for further information see paragraph "7.3.5 RUN in "Slave" mode".

During the normal functioning of the RUN, LEDs **L1...L8** will either be on or off depending on the state of the function they represent. For example, **L1** will be on if the "Automatic Closing" function is active.

7.2.2) Level one programming (ON-OFF functions)

Level 1 functions are all factory set to "OFF". However, they can be changed at any time as shown in Table 8. Follow the procedure carefully, as there is a maximum time of 10 seconds between pressing one key and another. If a longer period of time lapses, the procedure will finish automatically and memorize the modifications made up to that stage.

Table 8: changing ON-OFF functions		Example
1.	Press and hold key [Set] (approx. 3 s)	
2.	Release the [Set] key when L1 LED starts flashing	
3.	Press keys [▲] or [▼] to move the flashing LED onto the LED representing the function to be changed	
4.	Press the [Set] key to change the state of the function (short flashing = OFF; long flashing = ON)	
5.	Wait 10 seconds before leaving the programme to allow the maximum time to lapse.	

Note: Points 3 and 4 can be repeated during the same programming phases in order to set other functions to ON or OFF

7.2.3) Level two functions (adjustable parameters)

Table 9: programmable function list: level two				
Input LED	Parameter	Led (level)	Value	Description
L1	Pause Time	L1	5 Seconds	Adjusts the pause time, i.e. the time which lapses before automatic closure. This will only have an effect if automatic closing is active.
		L2	15 Seconds	
		L3	30 Seconds	
		L4	45 Seconds	
		L5	60 Seconds	
		L6	80 Seconds	
		L7	120 Seconds	
		L8	180 Seconds	
L2	Step-by-step Function	L1	Open - stop - close - stop	Manages the sequence of controls associated with the Step-by-Step input or to the 1st radio command.
		L2	Open - stop - close - open	
		L3	Open - close - open - close	
		L4	Apartment block	
		L5	Apartment block (more than 2" generates stop)	
		L6	Step-by-step 2 (less than 2" generates partial open)	
		L7	Dead man	
		L8	Opening in semi-automatic mode, closing in dead man mode	
L3	Motor speed	L1	Speed 0,06m/s	Adjusts motor speed during normal travel.
		L2	Speed 0,09m/s	
		L3	Speed 0,13m/s	
		L4	Speed 0,17m/s	
		L5	Speed 0,20m/s	
		L6	Speed 0,25m/s	
		L7	Speed 0,17m/s in opening; 0,09m/s in closing	
		L8	Speed 0,25m/s in opening; 0,17m/s in closing	
L4	Open gate indicator output	L1	Gate Open Indicator function	Adjust the function associated with the open gate indicator output (regardless of the associated function, when active, it supplies a voltage of 24V -30 +50% with maximum power of 4W).
		L2	Active if leaf closed	
		L3	Active if leaf open	
		L4	Active with radio output 2	
		L5	Active with radio output 3	
		L6	Active with radio output 4	
		L7	Maintenance indicator	
		L8	Electric lock	
L5	Obstacle detection sensitivity	L1	Extremely high sensitivity (lightweight gates)	Controls obstacle detection sensitivity.
		L2	Very high sensitivity	
		L3	High sensitivity	
		L4	Medium sensitivity	
		L5	Medium-low sensitivity	
		L6	Low sensitivity	
		L7	Very low sensitivity (heavyweight gates)	
		L8	Detention excluding (for gates with jolts)	

Input LED	Parameter	Led (level)	Value	Description
L6	Partial Open	L1	0,5 mt	The measurement of the partial opening. Partial opening can be controlled with the 2nd radio command or with "CLOSE", if the "Close" function is present, this becomes "Partial open".
		L2	1 mt	
		L3	1,5 mt	
		L4	2 mt	
		L5	2,5 mt	
		L6	3 mt	
		L7	3,4 mt	
		L8	4 mt	
L7	Maintenance warning	L1	Automatic (based on seriousness of manoeuvres)	Adjusts the number of manoeuvres after which it signals the maintenance request of the automation (see paragraph "7.4.4 Maintenance warning").
		L2	2.000	
		L3	4.000	
		L4	7.000	
		L5	10.000	
		L6	15.000	
		L7	20.000	
		L8	30.000	
L8	Fault list	L1	Manoeuvre 1 result (most recent)	The type of defect that has occurred in the last 8 manoeuvres can be established (see paragraph "7.6.1 Malfunctions archive").
		L2	Manoeuvre 2 result	
		L3	Manoeuvre 3 result	
		L4	Manoeuvre 4 result	
		L5	Manoeuvre 5 result	
		L6	Manoeuvre 6 result	
		L7	Manoeuvre 7 result	
		L8	Manoeuvre 8 result	

Note: "■" represents the factory setting

Note (1): Automatically regulates the force required, maintaining a minimum guaranteed force level.







Note (2): Automatically regulates the force required.

All parameters can be adjusted as required without any contraindications, only the "Obstacle detection sensitivity" and "Motor force control" may require special attention:

- Use of high force values are not recommended to compensate for the fact that the leaf has anomalous points of friction; excessive force may impair the safety system and damage the leaf.
- If the "Obstacle detection sensitivity" is used in support of the system for impact force reduction, after each adjustment the force measurement procedure must be performed, as envisaged by standard EN 12445.
- Wear and atmospheric conditions that influence movement of the gate; force settings should be checked periodically.

7.2.4) Level two programming (adjustable parameters)

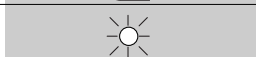
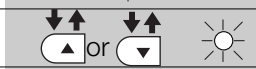









The adjustable parameters are factory set as shown in the table 9, with: "■" However, they can be changed at any time as shown in Table 10. Follow the procedure carefully, as there is a maximum time of 10 seconds between pressing one key and another. If a longer period of time lapses, the procedure will finish automatically and memorize the modifications made up to that stage.

Tabella 10: changing the adjustable parameters	Example
1. Press and hold key [Set] (approx. 3 s)	
2. Release the [Set] key when L1 LED starts flashing	
3. Press key [▲] or [▼] to move the flashing LED onto the input LED representing the parameter to be changed	
4. Press the key [Set] and hold it down during step 5 and 6	
5. Wait approx. 3 seconds, after which the LED representing the current level of the parameter to be modified will light up.	
6. Press key [▲] or [▼] to move the LED representing the parameter value.	
7. Release the key [Set]	
8. Wait 10 seconds before leaving the programme to allow the maximum time to lapse.	

Note: Points 3 to 7 can be repeated during the same programming phase in order to set other parameters

7.2.5 Level one programming example (ON-OFF functions).





















The sequence to follow in order to change the factory settings of the functions for activating “Automatic Closing” (L1) and “Always close” (L3) have been included as examples.)

Table 11: Level one programming	Example
1. Press and hold [Set] (approx. 3 s)	 3s
2. Release the [Set] key when L1 LED starts flashing	 L1 
3. Press [Set] once to change the state of the function associated with L1 (Automatic Closing). LED L1 will now flash with long flashes.	  L1
4. Press [▼] twice to move the flashing LED to LED L3	   L3
5. Press the [Set] key once to change the state of the function associated with L3 (Always Close). LED L3 will now flash with long flashes.	  L3
6. Wait 10 seconds before leaving the programme to allow the maximum time to lapse.	 10s

Once these operations have been completed, LEDs L1 and L3 must remain on to indicate that the “Automatic Closing” and the “Always Close” functions are active.

7.2.6 Level two programming example (adjustable parameters)

The example shows the sequence to follow in order to change the factory settings of parameters and increase the “Pause Time” to 60 seconds (input on L1 and level on L5) and reduce the “Motor Torque” of 60% (input on L5 and level on L3).

Table 12: Level two programming	Example
1. Press and hold [Set] (approx. 3 s)	 3s
2. Release [Set] when L1 LED starts flashing	 L1 
3. Press and hold [Set] during steps 4 and 5	
4. Wait approx. 3 seconds until LED L3, representing the current level of the “Pause Time” will light up	 L3 3s
5. Press [▼] twice to move the LED which is lit to LED L5, which represents the new “Pause Time” value	   L5
6. Release [Set]	
7. Press [▼] four times to move the flashing LED to LED L5	     L5
8. Press and hold [Set] during steps 9 and 10	
9. Wait approx. 3 seconds until LED L5, representing the current level of the “Motor Torque” will light up	3s  L5
10. Press [▲] twice to move the LED which is lit to LED L3, which represents the new “Motor Torque” value	   L3
11. Release [Set]	
12. Wait 10 seconds before leaving the programme to allow the maximum time to lapse.	 10s

7.3) Adding or removing devices

Devices can be added to or removed from the RUN automation system at any time. In particular, various devices types can be connected to “BlueBUS” and “STOP” input as explained in the following paragraphs.

After adding or removing any devices, the automation system must go through the self-learning process again according to the directions contained in paragraph 7.3.6 “Device self-learning”.

7.3.1) BlueBUS

BlueBUS technology enables the connection of compatible devices using only two wires which carry both the power supply and the communication signals. All the devices are connected in parallel on the 2 wires of the BlueBUS itself. It is not necessary to observe any polarity; each device is individually recognized because a univocal address is assigned to it during installation. Photocells, safety devices, control keys, signalling lights etc. can be connected to BlueBUS.

The RUN control unit recognizes all the connected devices individually through a suitable self-learning process, and can detect all the possible abnormalities with absolute precision. For this reason, each time a device connected to BlueBUS is added or removed, the control unit must go through the self-learning process; see paragraph 7.3.6 “Self-learning Other Devices”.

7.3.2) STOP input

STOP is the input that causes the immediate interruption of the manoeuvre (with a short reverse run). Devices with output featuring normally open “NO” contacts and devices with normally closed “NC” contacts, as well as devices with 8,2KΩ constant resistance output, such as sensitive edges, can be connected to this input.

During the self-learning stage the control unit, as in the case of BlueBUS, recognizes the type of device connected to the STOP input (see paragraph 7.3.6 “Self-learning Other Devices”); subsequently it commands a STOP whenever a change occurs in the recognized status.

Multiple devices, even of different type, can be connected to the STOP input if suitable arrangements are made:

- Any number of NO devices can be connected to each other in parallel.
- Any number of NC devices can be connected to each other in series.

- Two devices with 8.2KΩ constant resistance output can be connected “in parallel”; if necessary, multiple devices must be connected “in cascade” with a single 8.2KΩ termination resistance.
- It is possible to combine Normally Open and Normally Closed by making 2 contacts in parallel with the warning to place an 8.2KΩ resistance in series with the Normally Closed contact (this also makes it possible to combine 3 devices: Normally Open, Normally Closed and 8,2KΩ).

⚠ If the STOP input is used to connect devices with safety functions, only the devices with 8,2KΩ constant resistance output guarantee the fail-safe category 3 according to EN standard 954-1.

7.3.3) Photocells

By means of addressing using special jumpers, the “BlueBUS” system enables the user to make the control unit recognise the photocells and assign them with a correct detection function. The addressing procedure must be performed both on TX and RX (setting the jumpers in the same way) making sure there are no other pairs of photocells with the same address.

In an automation for sliding gates, RUN enables installation of the photocells as shown in Figure 24.

Each time a photocell is added or removed the control unit must go through the self-learning process; see paragraph 7.3.6 “Self-learning Other Devices”.

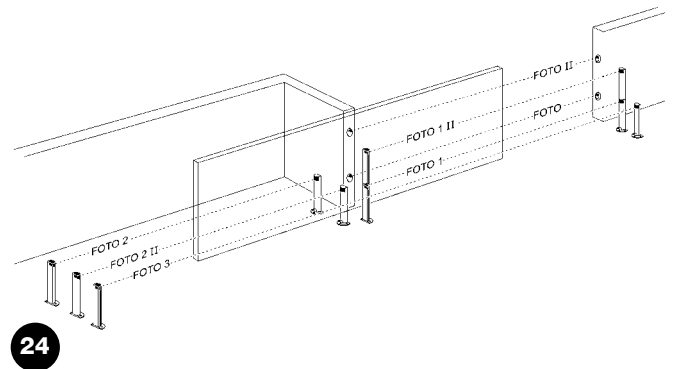

Table 13: Photocell addressing

Photocell	Jumpers	Photocell	Jumpers
PHOTOCELL External photocell h=50 cm activated when gate closes		PHOTOCELL 2 External photocell activated when gate opens	
PHOTOCELL II External photocell h=100 cm activated when gate closes		PHOTOCELL 2 II Internal photocell activated when gate opens	
PHOTOCELL 1 Internal photocell h = 50 cm activated when gate closes		PHOTOCELL 3 Single photocell for entire automation system	
PHOTOCELL 1 II Internal photocell h=100 cm activated when gate closes		<p>⚠ In the case of the installation of PHOTO 3 and PHOTO II together, the position of the photocell elements (TX-RX) must comply with the provisions contained in the photocell instruction manual</p>	

7.3.4) FT210B Photo-sensor

The FT210B photo-sensor combines a force limiting device (type C in accordance with the standard EN1245) and a presence detector which detects the presence of obstacles on an optical axis between the TX transmitter and the RX receiver (type D in accordance with the standard EN12453). The sensitive edge status signals on the FT210 photo-sensor are transmitted by means of the photocell beam, integrating the two systems in a single device. The transmitting part is positioned on the mobile leaf and is powered by a battery thereby eliminating unsightly connection systems; the consumption of the battery is reduced by special circuits guaranteeing a duration of up to 15 years (see the estimation details in the product instructions).

By combining a FT210B device with a sensitive edge (TCB65 for example) the level of security of the “primary edge”, required by the EN12453 standard for all “types of use” and “types of activation”, can be attained.

The FT210B is safe against individual faults when combined to a “resistive” type (8,2Kohm) sensitive edge. It features a special anti-collision circuit that prevents interference with other detectors, even if not synchronised, and allows additional photocells to be fitted; for example, in cases where there is a passage of heavy vehicles and a second photocell is normally placed at 1 m from the ground.

See the FT210B instruction manual for further information concerning connection and addressing methods.

7.3.5) RUN in "Slave" mode

When correctly programmed and connected, RUN can function in "Slave" mode; this type of function is used when 2 opposite gates need to be automated with the synchronised movement of the two leaves. In this mode RUN works as Master commanding the movement, while the second RUN acts as Slave, following the commands transmitted by the Master (all RUN are Masters when leaving the factory).

To configure RUN as a Slave level one "Slave mode" must be activated (see table 7).

The connection between RUN Master and RUN Slave is made via BlueBus.

⚠ In this case the polarity of the connections between the two RUN must be observed as illustrated in fig. 26 (the other devices remain with no polarity).

Follow the operations below to install 2 RUN in the Master and Slave mode:

- Install the 2 motors as indicated in fig. 25. It is not important which motor is to function as Slave or Master; when choosing, one must consider the convenience of the connections and the fact that the Step-by-Step command of the Slave only allows the Slave leaf to be opened fully.

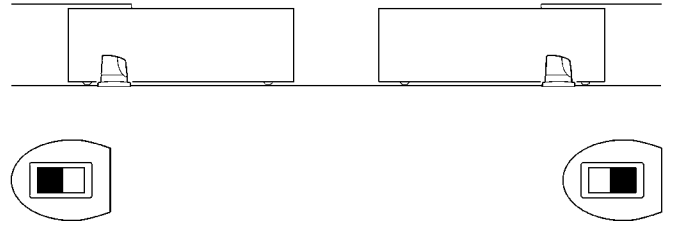

25

- Connect the 2 motors as shown in fig. 26.
- Select the opening direction of the 2 motors as shown in fig. 25 (see also paragraph "4.1 Choosing the direction").
- Supply power to the 2 motors.
- Program the "Slave mode" on the RUN Slave (see table 7).
- Perform the device self-learning on the RUN Slave (see paragraph "4.3 Self-learning devices").
- Perform the device self-learning on the RUN Master (see paragraph "4.3 Self-learning devices").
- Perform the self-learning of the leaf length on the RUN Master (see paragraph "4.4 Leaf length self-learning").

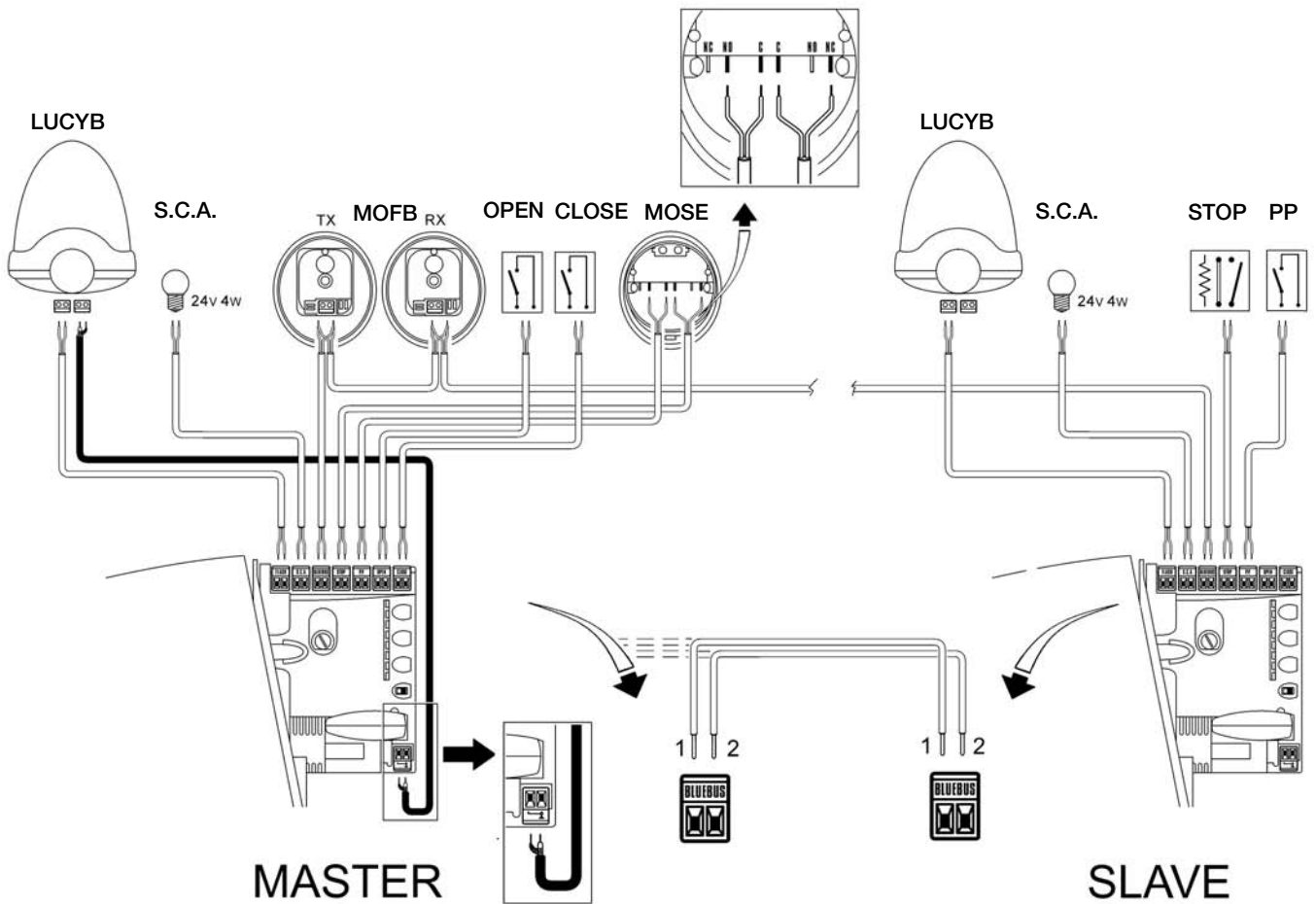

26

When connecting 2 RUN in the Master-Slave mode, strictly observe the following:

- All devices must be connected to the RUN Master (as in fig. 26) including the radio receiver.
- All programming performed on RUN Slave is ignored (that on RUN Master overrides the others) except for those mentioned in table 14.

Table 14: RUN Slave programming independently from RUN Master

Level one functions (ON-OFF functions)	Level two functions (adjustable parameters)
Stand-By	Obstacle detection sensitivity
Peak	Open Gate Indicator output
Slave Mode	Motor torque control
	Fault list

On Slave it is possible to connect:

- A flashing light (Flash)
- An open gate indicator (S.C.A.)
- A sensitive edge (Stop)
- A command device (Step by Step) that controls the complete opening of the Slave leaf only.
- The Open and Close inputs are not used on the Slave

7.3.6) Self-learning Other Devices

Normally the self-learning of the devices connected to the BlueBUS and the STOP input takes place during the installation stage. However, if new devices are added or old ones removed, the self-learning process can be repeated by proceeding as shown in Figure 15.

Table 15: Self-learning Other Devices

	Example
1. Press and hold keys [▲] and [Set]	
2. Release the keys when leds L1 and L2 start flashing very quickly (after approx. 3 s)	
3. Wait a few seconds for the control unit to finish self-learning the devices	
4. When the self-learning stage is complete, leds L1 and L2 will turn off, the STOP LED must remain on, while leds L1...L8 will light up according to the status of the relative ON-OFF functions.	

⚠ After adding or removing any devices, the automation system must be tested again according to the instructions in paragraph 5.1 “Testing”.

7.4) Special functions

7.4.1) “Always open” Function

The “Always open” function is a control unit feature which enables the user to control an opening manoeuvre when the “Step-by-Step” command lasts longer than 2 seconds. For example, this is useful for connecting a timer contact to the “Step-by-Step” terminal in order to keep

the gate open for a certain length of time. This feature is valid with any kind of “Step-by-Step” input programming, except for “Apartment block 2”. Refer to the “Step-by-Step Function” parameter in Table 9.

7.4.2) “Move anyway” function

In the event that one of the safety devices is not functioning properly or is out of use, it is still possible to command and move the gate in “Dead man” mode.

Please refer to the Paragraph “Control with safety devices out of order” in the enclosure “Instructions and Warnings for users of the RUN gearmotor” for further information.

7.4.3) Heating and cooling control system

RUN is equipped with a sophisticated system for the control of the motor temperature. The internal value of RUN is read by a special sensor and used for the management of the conditioning system, to enable heating of the motor when external temperatures fall below a

threshold of around 0°C (if the “heating” function is enabled via the remote programming unit “OperaView”); or enable accelerated cooling of the motor when temperatures exceed a value of around 40°C.

7.4.4) Maintenance warning

With RUN the user is notified when the automation requires a maintenance inspection. The number of manoeuvres after the warning can be selected from 8 levels, by means of the “Maintenance warning” adjustable parameter (see table 9). Adjustment level 1 is “automatic” and takes into consideration the severity of the manoeuvre, this being the force and duration of the manoeuvre, while the other adjustments are established according to the number of manoeuvres.

The maintenance request warning is by means of the Flashing light or on the Open Gate indicator output when this is programmed as a “Maintenance Indicator” (see table 9).







The flashing light “Flash” and the maintenance light give the signals indicated in table 16, based on the number of manoeuvres performed according to the limits programmed.

Table 16: maintenance warning with Flash and maintenance light

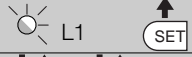
Number of manoeuvres	Flash signal	Maintenance indicator signal
Below 80% of limit	Normal (0.5s on, 0.5s off)	Lit for 2s at start of opening
Between 81 and 100% of limit	At start of manoeuvre remains lit for 2s then proceeds as normal	Flashes throughout manoeuvre
Over 100% of limit	At start and end of manoeuvre remains lit for 2s then proceeds as normal	Flashes continuously



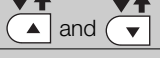



Check of number of manoeuvres performed

The number of manoeuvres performed as a percentage of the set limit can be verified by means of the "Maintenance warning" function. Follow the indications in table 17 for this check.

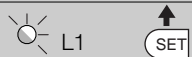
	Example
1. Press and hold [Set] (approx. 3 s)	 3s
2. Release [Set] when led L1 starts flashing	
3. Press key [▲] or [▼] to move the flashing LED onto the input LED L7 representing the "Maintenance warning" parameter	
4. Press and hold [Set] during steps 5, 6 and 7	
5. Wait approx. 3 seconds, after which the LED representing the current level of the parameter "Maintenance warning" will light up.	
6. Press and immediately release the [▲] and [▼] keys.	
7. The LED that corresponds to the selected level flashes. The number of flashes indicates the percentage of manoeuvres performed (in multiples of 10%) in relation to the set limit. For example: with the maintenance warning set on L6 being 10000, 10% is equal to 1000 manoeuvres; if the LED flashes 4 times, this means that 40% of the manoeuvres have been reached (between 4000 and 4999 manoeuvres). The LED will not flash if 10% of the manoeuvres has not yet been reached.	
8. Release the key [Set]	

Manoeuvre counter reset

After the maintenance of the system has been performed the manoeuvre counter must be reset. Proceed as described in table 18.

	Example
1. Press and hold [Set] (approx. 3 s)	 3s
2. Release [Set] when led L1 starts flashing	
3. Press key [▲] or [▼] to move the flashing LED onto the input LED L7 representing the "Maintenance warning" parameter	
4. Press and hold [Set] during steps 5 and 6	
5. Wait approx. 3 seconds, after which the LED representing the current level of the parameter "Maintenance warning" will light up.	
6. Press and hold keys [▲] and [▼] , for at least 5 seconds and then release. The LED that corresponds to the selected level flashes rapidly indicating that the manoeuvre counter has been reset.	
7. Release the key [Set] .	

7.5) Connection of Other Devices

If the user needs to feed external devices such as a proximity reader for transponder cards or the illumination light of the key-operated selector switch, it is possible to tap power as shown in Figure 27. The power supply voltage is 24Vdc -30% - +50% with a maximum available current of 100mA.

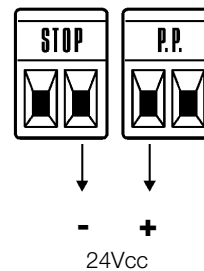

7.6) Troubleshooting

Table 19 contains instructions to help solving malfunctions or errors that may occur during the installation stage or in case of failure.

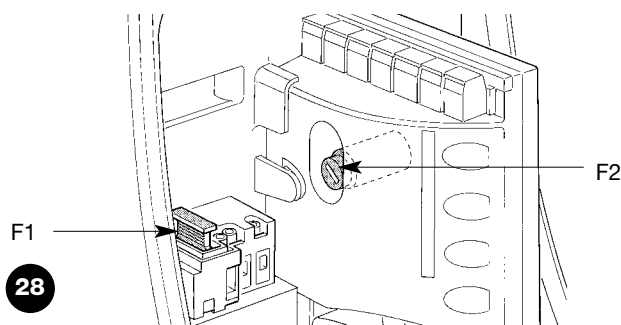













Table 19: Troubleshooting	
Symptoms	Recommended checks
The radio transmitter does not control the gate and the LED on the transmitter does not light up.	Check to see if the transmitter batteries are discharged, if necessary replace them
The radio transmitter does not control the gate but the LED on the transmitter lights up	Check to see if the transmitter has been memorised correctly in the radio receiver
No manoeuvre starts and the "BlueBUS" LED does not flash	Check that RUN is powered by a 230V mains supply. Check to see if the fuses are blown; if necessary, locate the reason for the failure and then replace the fuses with others of the same current rating and characteristics.
No manoeuvre starts and the flashing light is off	Make sure that the command is actually received. If the command reaches the STEP-BY-STEP input, the corresponding "STEP-BY-STEP" LED must light up; if you are using the radio transmitter, the "BlueBus" LED must make two quick flashes.
No manoeuvre starts and the flashing light flashes a few times	Count the flashes and check the corresponding value in table 21
The manoeuvre starts but it is immediately followed by a reverse run	The selected level of obstacle detection sensitivity could be too high for the type of gate. Check to see whether there are any obstacles; if necessary select a lower level of sensitivity.
The manoeuvre is carried out but the flashing light does not work	Make sure that there is voltage on the flashing light's FLASH terminal during the manoeuvre (being intermittent, the voltage value is not important: approximately 10-30Vdc); if there is voltage, the problem is due to the lamp; in this case replace the lamp with one of the same characteristics; if there is no voltage, there may have been an overload on the FLASH output. Check that the cable has not short-circuited.
The manoeuvre is carried out but the Open Gate Indicator does not work	Check the type of function programmed for the Gate Open indicator output (L4 on table 9). When the indicator should be lit, check that there is voltage on the Open Gate Indicator terminal (approx. 24 Vdc); if voltage is present the problem is caused by the light, which will have to be replaced with one with the same characteristics. If there is no voltage, there may have been an overload on the open gate indicator output. Check that the cable has not short-circuited.

7.6.1) Malfunctions archive

RUN enables the user to view the possible malfunctions that have occurred in the last 8 manoeuvres; for example, the interruption of a manoeuvre due to a photocell or sensitive edge cutting in. To verify the malfunctions list, proceed as in table 20.

Table 20: malfunctions archive		Example
1. Press and hold [Set] (approx. 3 s)		 3s
2. Release [Set] when led L1 starts flashing		 L1 
3. Press key [▲] or [▼] to move the flashing LED onto the input LED L8 representing the "malfunctions list" parameter		 or   L8
4. Press and hold [Set] during steps 5 and 6		
5. Wait for about 3s after which the LEDs corresponding to the manoeuvres in which the defect occurred will light. The L1 LED indicates the result of the last manoeuvre and L8 indicates the result of the 8th manoeuvre. If the LED is on, this means that a defect occurred during that manoeuvre; if the LED is off, this means that no defect occurred during that manoeuvre.		3s 
6. Press keys [▲] and [▼] to select the required manoeuvre: The corresponding LED flashes the same number of times as those made by the flashing light after a defect (see table 21).		 and  
7. Release the key [Set] .		

7.7) Diagnostics and signals

A few devices issue special signals that enable identification of operating status or possible malfunctions.

7.7.1) Flashing light signalling

During the manoeuvre the flashing light FLASH flashes once every second. When something is wrong the flashes are more frequent; the light flashes twice with a pause of a second between flashes.

Table 21: FLASH flashing light signalling

Quick flashes	Cause	ACTION
1 flash 1 second pause 1 flash	Error on BlueBUS	At the start of the manoeuvre, the devices connected to BLUEBUS do not correspond to those recognized during the self-learning phase. One or more devices may be faulty; check and, if necessary, replace them; in case of modifications repeat the self-learning process (7.3.4 Self-learning Other Devices).
2 flashes 1 second pause 2 flashes	Activation of a photocell	At the start of the manoeuvre, one or more photocells do not enable it; check to see if there are any obstacles. This is normal when there is an obstacle impeding the movement.
3 flashes 1 second pause 3 flashes	Activation of "obstacle detection"	During the movement, the gate experienced excessive friction; identify the cause.
4 flashes 1 second pause 4 flashes	Activation of STOP input	At the start of the manoeuvre or during the movement, the STOP input was activated; identify the cause
5 flashes 1 second pause 5 flashes	Error in parameters in electronic control unit	Wait at least 30 seconds, then try giving a command. If the condition persists it means there is a malfunction and the electronic board has to be replaced
6 flashes 1 second pause 6 flashes	Maximum limit of manoeuvres per hour exceeded	Wait for a few minutes until the manoeuvre limiting device falls to below the maximum limit
7 flashes 1 second pause 7 flashes	Error in internal electrical circuits	Disconnect all the power circuits for a few seconds and then try to give the command again. If the condition persists it means there is a serious malfunction and the electronic board has to be replaced
8 flashes 1 second pause 8 flashes	A command is already present that disables execution of other commands	Check the type of command that is always present; for example, it could be a command from a timer on the "open" input.

7.7.2) Signals on the control unit

On the RUN control unit there is a set of LED's each of which can give special indications both during normal operation and in case of malfunctions.

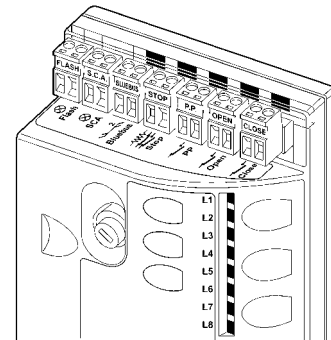

Table 22: LED's on the control unit's terminals

BLUEBUS LED	Cause	ACTION
Off	Fault	Make sure there is power supply; check to see if the fuses are blown; if necessary, identify the reason for the failure and then replace the fuses with others of the same characteristics
On	Serious fault	There is a serious malfunction; try switching off the control unit for a few seconds; if the condition persists it means there is a malfunction and the electronic board has to be replaced
One flash every second	All OK	Normal operation of control unit
2 quick flashes	Input status variation occurred	This is normal when there is a change in one of the inputs: STEP-BY-STEP, STOP, OPEN, CLOSE, triggering of photocells or the radio transmitter is used
Series of flashes separated by a one second pause	Various	Same signal as on flashing light. See table 21
STOP led	Cause	ACTION
Off	Activation of STOP input	Check the devices connected to the STOP input
On	All OK	STOP input active
S.S. Led	Cause	ACTION
Off	All OK	S.S. input not active
On	Activation of S.S. input	Normal if the device connected to the S.S. input is effectively active
OPEN Led	Cause	ACTION
Off	All OK	OPEN input not active
On	Activation of OPEN input	Normal if the device connected to the OPEN input is effectively active
CLOSE Led	Cause	ACTION
Off	All OK	Close input not active
On	Activation of CLOSE input	Normal if the device connected to the CLOSE input is effectively active

Table 23: leds on control unit keys

Led 1	Description
Off	During normal operation indicates "Automatic closing" not active
On	During normal operation indicates "Automatic closing" active
Flashing	<ul style="list-style-type: none"> Function programming in progress If flashing with L2 indicates need for device self-learning phase (see paragraph "4.3 Device self-learning").
Led L2	Description
Off	During normal operation indicates "Reclose after Photo" not active
On	During normal operation indicates "Reclose after Photo" active
Flashing	<ul style="list-style-type: none"> Function programming in progress. If flashing with L1, indicates need for device self-learning phase (see paragraph "4.3 Device self-learning")
Led L3	Description
Off	During normal operation indicates "Always close" not active.
On	During normal operation indicates "Always close" active.
Flashing	<ul style="list-style-type: none"> Function programming in progress. If flashing with L4 indicates need for device self-learning phase (see paragraph "4.3 Device self-learning")
Led L4	Description
Off	During normal operation the device indicates "Stand-by" not active.
On	During normal operation the device indicates "Stand-by" active.
Flashing	<ul style="list-style-type: none"> Function programming in progress. If flashing with L3 indicates need for leaf length self-learning phase (refer to Paragraph "4.4 Leaf length Self-learning").
Led L5	Description
Off	During normal operation indicates "Thrust" not active.
On	During normal operation indicates "Thrust" active.
Lampeggia	Function programming in progress.
Led L6	Description
Off	During normal operation indicates "Pre-flash" not active.
On	During normal operation indicates "Pre-flash" active.
Flashing	Function programming in progress
Led L7	Description
Off	During normal operation indicates that the CLOSE input activates a close manoeuvre
On	During normal operation indicates that the CLOSE input activates a partial opening manoeuvre.
Flashing	Function programming in progress
Led L8	Description
Off	During normal operation indicates that RUN is configured as Master
On	During normal operation indicates that RUN is configured as Slave
Flashing	Function programming in progress

7.8) Accessories

The following optional accessories are available for RUN:

- SMXI or SMXIS: Radio receiver at 433.92MHz with digital Rolling Code encoding.
- ONEXI: Radio receiver at 433.92MHz with digital Rolling Code encoding; equipped with Modo III to send 15 types of command to control unit

- OperaView; Remote programming unit.
- Consult the Nice S.p.a. product catalogue for the complete and updated list of accessories.

7.8.1) Remote programming unit

More specifically, connector BusT4 (see figure 30) enables connection of the remote programming unit Oview which enables complete and rapid management of installation, maintenance and troubleshooting of any malfunctions.

To access the connector, remove the membrane as shown in figure 31. The remote programming unit can be placed at a distance from the control unit, with up to 100m of cable; it can be connected simultaneously to up to 16 and can remain connected during normal operation of RUN; in this case a specific "user" menu enables delivery of commands to the control unit.

If a OXI (o OXIT) type radio receiver is inserted in the control unit, the remote programming unit enables access to the parameters of the memorised transmitters.

These functions require a 4-core connection cable (BusT4).

The RUN control unit firmware can also be updated. Further information is available in the Oview programmer instruction manual.

IMPORTANT – For further details on all functions of the NiceOpera system and interdependency of the various devices in the system, refer to the general manual "NiceOpera System Book", also available on the Internet site www.niceforyou.com.

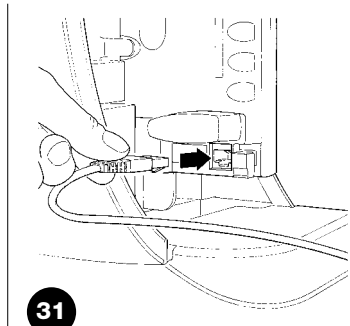
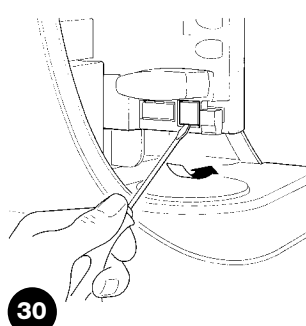

8) Technical characteristics

With the aim of improving products, Nice S.p.a reserves the right to modify technical characteristics at any time without notice, while maintaining the same functionalities and intended use.

All technical characteristics stated refer to an ambient temperature of 20°C (±5°C).

RUN Technical characteristics	
Model type	RUN 2500i
Type	Electromechanical gearmotor with three-phase motor for automatic movement of sliding gates for industrial use complete with electronic control unit and inverter.
Pinion	Number of teeth 18; Module 4 *
Maximum torque on start-up [corresponds to ability of generating the force required to move the leaf]	60Nm (1660N)
Nominal torque [corresponds to the ability of generating the force to maintain the leaf in movement]	25Nm (830N)
Speed (no-load)	17m/min)
Speed (at nominal torque)	15m/min)
Maximum frequency of operating cycles (at nominal torque)	28 cycles/hour (672 cycles/day), for a gate of 15m (equal to a cycle of 93%), (the control unit limits cycles to the maximum number specified in tables 2 and 3)**
Maximum time of continuous operation (at nominal torque)	45 minutes (the control unit limits continuous operation to the maximum limits as specified in tables 2 and 3)***
Operating limits	In general RUN is designed for the automation of gates with the weights and lengths as specified in tables 2, 3 and 4
Durability	Estimated between 200.000 cycles and 600.000 cycles according to conditions specified in table 4
Power supply RUN 2500i	230Vac (+10% -15%) 50 Hz
Maximum power absorption on start-up [corresponding to Amps]	650 W [3.8 A]
Power at nominal torque [corresponding to Amps]	450 W [2.7 A]
Insulation class	1 (safety earthing required)
Flashing light output	For 2 Flashing lights LUCYB (lamp 12V, 21W)
Gate open indicator output	For 1 24V lamp of maximum 4W (output voltage may vary between -30 and +50% and can also control small relays)
BLUEBUS output	One output with maximum load of 15 BlueBus units
STOP input	For normally closed contacts , normally open contacts or with constant 8,2KΩ. resistance; in self-learning (a variation with respect to memorised value generates the STOP command)
Step-by-step input	For normally open contacts (contact closure generates S.S. command)
OPEN input	For normally open contacts (contact closure generates OPEN command)
CLOSE input	For normally open contacts (contact closure generates CLOSE command)
Radio connector	SM connector for receivers SMXI; SMXIS or ONEXI
Radio ANTENNA input	Input ANTENNA Radio 52Ω for cable type RG58 or similar
Programmable functions	8 ON-OFF type functions and 8 settable functions (see tables 7 and 9)
Functions in self-learning mode	Self-learning of devices connected to BlueBus output. Self-learning of "STOP" device type (contact NO, NC or 8,2KΩ resistance) Self-learning of gate length and calculation of deceleration and partial opening points.
Operating temperature	-20°C ÷ 50°C
Use in particularly acidic, saline or potentially explosive atmospheres	No
Protection rating	IP 44
Dimensions and weight	400 x 255 h 390; 24.5Kg

Congratulations for having chosen a Nice product for your automation system! Nice S.p.A. produces components for the automation of gates, doors, rolling gates, roller shutters and awnings: gearmotors, control units, radio controls, flashing lights, photocells and miscellaneous accessories. Nice uses only the finest materials and first-class workmanship. It focuses on the development of innovative solutions designed to simplify the use of its equipment, dedicating meticulous care to the study of its technical, aesthetic and ergonomic characteristics: From the wide range of Nice products, your installation technician will certainly have selected the one best suited to your specific requirements. However, Nice is not the producer of your automation system, which is rather the result of a combination of operations carried out by your installation technician, namely analysis, evaluation, selection of materials and system implementation. Each automation system is unique. Your installation technician is the only person who possesses the experience and professionalism needed to set up a system capable of satisfying your requirements, a system that is safe, reliable, long lasting and built in accordance with the regulations in force. An automation system is not only very convenient; it also improves the level of security in your home. Moreover, it will last for years with very little maintenance. Even though the automation system you possess meets the safety requirements of the legislation in force, this does not exclude the existence of a "residual risk", i.e. the possibility that dangers may arise, usually as a result of improper or unreasonable use. We have prepared the following list of do's and don'ts to help you avoid any mishaps:

- **Before using your automation system for the first time**, ask the installer to explain the origin of residual risks; take a few minutes and read the users **instructions manual given you by the installer**. Retain the manual for future use and deliver it to any subsequent owner of the automation system.

- **Your automation system is a machine that will faithfully execute your commands**; unreasonable or improper use may generate dangers: do not operate the system if there are people, animals or objects within its range of operation.

- **Children**: automation systems are designed to guarantee high levels of safety and security. They are equipped with detection devices that prevent movement if people or objects are in the way, guaranteeing safe and reliable activation. However, children should not be allowed to play in the vicinity of automated systems; to prevent any accidental activations, keep all remote controls away from children: **they are not toys!**

- **Malfunctions**: If you notice that your automation is not functioning properly, disconnect the power supply

to the system and operate the manual release device. Do not attempt to make any repairs; call the installation technician and in the meantime, operate the system like a non-automatic door after releasing the gearmotor as described below.

- **Maintenance**: Like any machine, your automation needs regular periodic maintenance to ensure its long life and total safety. Arrange a periodic maintenance schedule with your installation technician. Nice recommends that maintenance checks be carried out every six months for normal domestic use, but this interval may vary depending on the intensity of use. Only qualified personnel are authorised to carry out checks, maintenance operations and repairs.

- Do not modify the system or its programming and adjustment parameters in any way, even if you feel capable of doing it: your installation technician is responsible for the system.

- The final test, the periodic maintenance operations and any repairs must be documented by the person who has performed them; these documents must remain under the custody of the owner of the system.

The only recommended maintenance operations that the user can perform periodically concern the cleaning of the photocell glasses and the removal of **leaves and debris that may impede the automation**. To prevent anyone from activating the gate release the automation system (as described below). Use a slightly damp cloth to clean.

- **Disposal**: At the end of its useful life, the automation must be dismantled by qualified personnel, and the materials must be recycled or disposed of in compliance with the legislation locally in force.

- **In the event of malfunctions or power failures**. While you are waiting for the technician to come (or for the power to be restored if your system is not equipped with buffer batteries), you can operate the system like any non-automatic gate. In order to do this you need to manually release the gearmotor (this operation is the only one that the user of the automation is authorized to perform): This operation has been carefully designed by Nice to make it extremely easy, without any need for tools or physical exertion.

Manual movement and release: before carrying out this operation please note that release can only occur when the leaf is stopped.

1 Slide the lock cover disc.

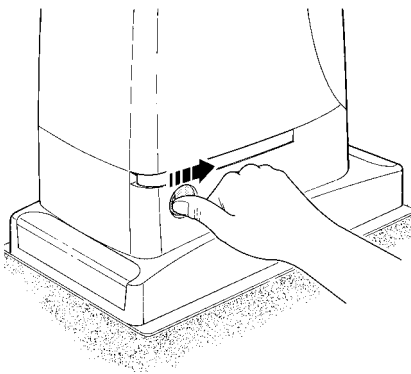

2 Insert and turn the key clockwise.

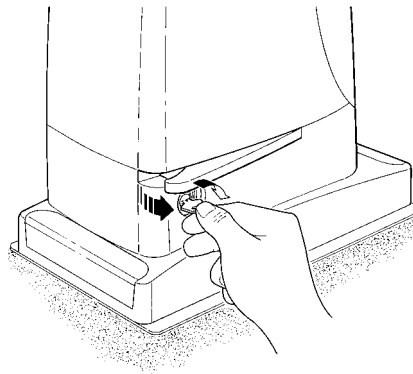

3 Pull the release handle.

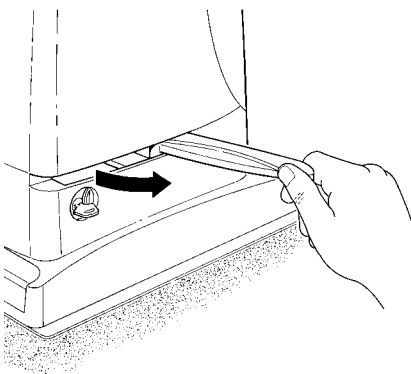

4 Move the leaf manually.

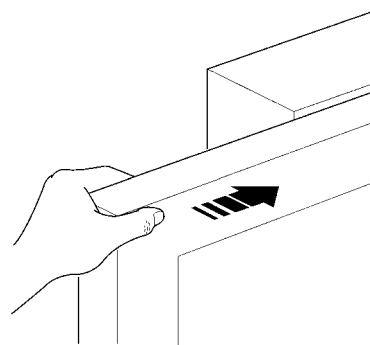

To lock: carry out the same procedures backwards.

Control with safety devices out of order: If the safety devices are malfunctioning, it is still possible to control the gate.

- Operate the gate control device (remote control or key-operated selector switch, etc.). If the safety devices enable the operation, the gate will open and close normally, otherwise the flashing light flashes a few times but the manoeuvre does not start (the number of flashes depends on the reason why the manoeuvre is not enabled).
- In this case, **actuate the control** again within 3 seconds and keep it actuated.
- After approximately 2s the gate will start moving in the "man present" mode, i.e. so long as the control is maintained the gate will keep moving; as soon as the control is released the gate will stop.

⚠ If the safety devices are out of order the automation must be repaired as soon as possible.

Replacing the Remote Control Battery: if your radio control, after a period of time, seems not to work as well, or not to work at all, it may simply be that the battery is exhausted (depending on the type of use, it may last from several months up to one year and more). In this case you will see that the light confirming the transmission is weak, or does not come on, or comes on only briefly. Before calling the installation technician try exchanging the battery with one from another operating transmitter:

if the problem is caused by a low battery, just replace it with another of the same type. The batteries contain polluting substances: do not dispose of them together with other waste but use the methods established by local regulations.

Are you satisfied? If you wish to install another automation system in your home, call your old installation technician and use Nice products. You will get the services of a specialist and the most advanced products available on the market, superior performances and maximum system compatibility. Thank you for reading these instructions. We feel confident that you will be well satisfied with your new system: for any present or future requirements, please contact your reliable installation technician.

